



Solares

AND CO. INC.

Industrial Equipment Suppliers

PRODUCT CATALOGUE

TO SERVICE, COMMITTED QUALITY AND DELIVERY SINCE 1959

Carretera 28 Km. 2.1 Luchetti Ind. Park Bayamon, P.R. 00960

T: +787-620-5454 • F: +787-620-5468

www.solaresco.com



Carretera 28 Km. 2.1 Luchetti Ind. Park Bayamon, P.R. 00960

T: +787-620-5454 • F: +787-620-5468

www.solaresco.com

TABLE OF CONTENTS

PUMPS	1
COMPRESSORS	27
VALVES	35
SERVICE STATION EQUIPMENT	41
LPG & AMMONIUM EQUIPMENT	81
METERS	91
FILTERS	103
LOADING RACKS & TANK TRUCK EQUIPMENT	109
MISCELLANEOUS	123
CUSTOM MADE EQUIPMENT	135

PUMPS



X Sliding Vane Pumps

- Unique sliding-vane pump design self-adjusts for wear to maintain flow rates
- Excellent self-priming and dry run capabilities
- Blackmer mechanical seal and ball bearing construction provide maximum reliability
- Symmetrical bearing support assures even loading and wear for long life
- Adjustable relief valve protects pump against excessive pressures
- External ball bearings are isolated from pumpage by mechanical seals to maximize bearing life and minimize contamination risk
- Easy maintenance: vanes can be easily replaced without removing the pump from the piping system



TX Sliding Vane Pumps

- Unique sliding-vane pump design self-adjusts for wear to maintain flow rates
- Excellent self-priming and dry-run capabilities
- Dual-ended shaft on 2-, 2.5- and 3-inch models simplifies installation
- Blackmer mechanical seal and ball-bearing construction provide maximum reliability
- Symmetrical bearing support assures even loading and wear for long life
- Adjustable relief valve protects pump against excessive pressures
- External ball-bearings are isolated from pumpage by mechanical seals to maximize bearing life and minimize contamination risk
- Easy maintenance: vanes can be easily replaced -- without removing pump from truck



LGL Sliding Vane Pumps

- Pumps are listed by Underwriters Laboratory for both LP-Gas and anhydrous ammonia service
- Cavitation suppression liner design for reducing the noise, vibration, and wear normally caused by entrained vapors
- Replaceable casing liners and end discs allow easy rebuilding of the pumping chamber to like-new condition
- Ductile iron construction with internal relief valve
- Unique sliding-vane pump design self-adjusts for wear to maintain flow rates
- Excellent self-priming and dry run capabilities
- Blackmer mechanical seal and ball bearing construction provide maximum reliability
- Symmetrical bearing support assures even loading and wear for long life
- Relief valve protects pump against excessive pressures
- External ball bearings are isolated from pumpage by mechanical seals to maximize bearing life and minimize contamination risk
- Easy maintenance: vanes can be easily replaced without removing the pump from the piping system

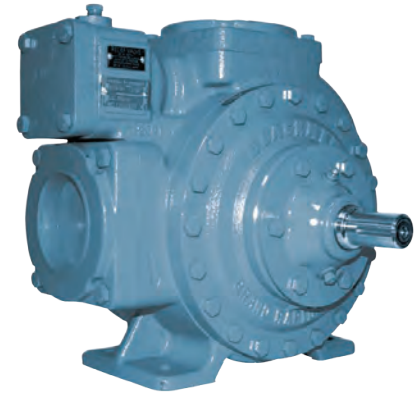

System One Centrifugal Pumps

- High-strength, low maintenance line of innovative process pumps
- Designed specifically for the toughest, most extreme environments
- Sets the industry standard for high quality and durability
- Designed around the seal and bearings where 90% of failures occur
- Designed to maximize system reliability – stronger, more vibration-resistant pump
- Heavy-duty, solid, low deflection shaft prevents common vibration damage and greater stability at the seal area to improve seal life
- Heavy-duty bearings offer greater load capacity and extend bearing life
- Patented System One® Labyrinth Seals provide non-wearing lifetime protection for radial and thrust bearings



3600 Series

General purpose pumps for transferring, mixing, blending and recirculating. Efficiently handles heavy, viscous materials such as: asphalt, molasses, chocolate, roofing compounds, and printing inks. Also suitable for fuel oil, gasoline, and other similar thin liquids.



No. of Sizes	Theoretical Max Capacity	Differential Pressure	Viscosity	Max Temp.	Port Sizes	Housing Materials of Construction
8	360 GPM	125 PSI	Up to 55,000 cSt	212°/450°F	2" - 3" NPT	Cast Iron
	81.8 M ³ /hr	8.6 Bar	up to 250,000 SSU	100°/232°C	2" - 4" Flg	

Z Series

Easy maintenance, two-piece backplate for flexible sealing options (single, double or cartridge seals). Designed around our 3600 series pump with a more advanced seal chamber and optional ANSI flanges. Ideal for chemical and petroleum applications.

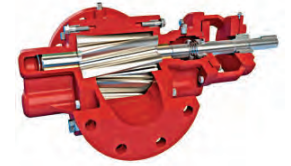

No. of Sizes	Theoretical Max Capacity	Differential Pressure	Viscosity	Max Temp.	Port Sizes	Housing Materials of Construction
7	360 GPM	125 PSI	Up to 55,000 cSt	212°/450°F	2" - 3" NPT	Cast Iron
	81.8 M ³ /hr	8.6 Bar	up to 250,000 SSU	100°/232°C	2" - 4" Flg	

3800 Series

Easy maintenance, two-piece backplate for flexible sealing options (single, double or cartridge seals). Designed around our 3600 series pump with a more advanced seal chamber and optional ANSI flanges. Ideal for chemical and petroleum applications.

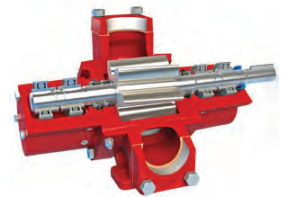

No. of Sizes	Theoretical Max Capacity	Differential Pressure	Viscosity	Max Temp.	Port Sizes	Housing Materials of Construction
4	540 GPM	125 PSI	Up to 55,000 cSt	250°/350°F	3" - 4" NPT	Cast Iron with sealed ball bearings
	122.6 M ³ /hr	8.6 Bar	up to 250,000 SSU	121°/176°C		

9600 Series

Heavy duty corrosion resistant stainless steel pump for chemical transfer. Typically used for corrosive liquids, polymers and petro-chemicals.



No. of Sizes	Theoretical Max Capacity	Differential Pressure	Viscosity	Max Temp.	Port Sizes	Housing Materials of Construction
1	165 GPM	100 PSI	Up to 55,000 cSt	350°F	3" Flg	316/17-4 PH
	37.5 M ³ /hr	7 Bar	up to 250,000 SSU	176°C		Stainless Steel

Bulk Handling Series

High capacity transfer pumps designed for a wide variety of bulk liquids in loading and unloading applications: barges, railway tank cars and transport tankers.

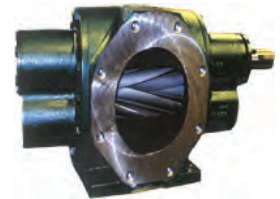

No. of Sizes	Theoretical Max Capacity	Differential Pressure	Viscosity	Max Temp.	Port Sizes	Housing Materials of Construction
2	1045 GPM	125 PSI	Up to 55,000 cSt	250°/500°F	8" Flg	Ductile Iron
	81.8 M ³ /hr	8.6 Bar	up to 250,000 SSU	100°/232°C	2" - 4" Flg	Cast Iron

5600 Series

Rubber gear pump specifically designed for handling liquids with high solid content and abrasives. Often used for oilfield service, hydro-seeding, waste oils tallow and sludges.

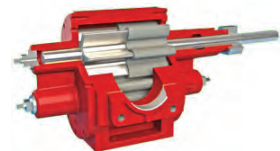

No. of Sizes	Theoretical Max Capacity	Differential Pressure	Viscosity	Max Temp.	Port Sizes	Housing Materials of Construction
1	232 GPM	100 PSI	Up to 2,200 cSt	160°F	3" Flg	Cast Iron with sealed
	52.7 M ³ /hr	7 Bar	up to 10,000 SSU	71°C		NITRILE

A Series

General purpose pumps for pressure lubrications, hydraulic service, fuel supply and general transfer. Capable of operating at standard motor speeds. Pressures up to 300 PSI.



No. of Sizes	Theoretical Max Capacity	Differential Pressure	Viscosity	Max Temp.	Port Sizes	Housing Materials of Construction
12	75.6 GPM	150/300 PSI	Up to 2,200 cSt	212°/500°F	3/8" - 2" NPT	Ductile Iron, Cast Iron
	17.2 M ³ /hr	10/20 Bar	up to 10,000 SSU	100°/260°C		

2835 Series

High viscosity pump designed to run at standard motor speeds with liquid viscosities up to 100,000 SSU. Commonly used for pumping molasses, feed supplements and roofing compounds.



No. of Sizes	Theoretical Max Capacity	Differential Pressure	Viscosity	Max Temp.	Port Sizes	Housing Materials of Construction
1	11.3 GPM	75 PSI	Up to 22,000 cSt	200°/450°F	1 1/2" NPT	Cast Iron
	2.57 M ³ /hr	5.2 Bar	up to 100,000 SSU	93°/232°C		

ROC Series

Heavy duty stainless steel pumps for the chemical and pharmaceutical industries. Used for dosing and transferring of acids and solvents. Available with magnetic drive on small sizes.

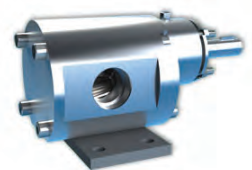

No. of Sizes	Theoretical Max Capacity	Differential Pressure	Viscosity	Max Temp.	Port Sizes	Housing Materials of Construction
8	32.4 GPM	300 PSI	Up to 55,000 cSt	350°F	1/2" - 2" NPT	316/17.4 Stainless Steel
	7.36 M ³ /hr	20 Bar	up to 250,000 SSU	176°C		

V Series

Magnetic drive, seal-less helical gear pump designed for ultra-safe transfer of hazardous or toxic liquids. Ideal for environmental concerns or where “zero leakage” is an issue.



No. of Sizes	Theoretical Max Capacity	Differential Pressure	Viscosity	Max Temp.	Port Sizes	Housing Materials of Construction
4	5.4 GPM	150 PSI	Up to 2,200 cSt	225°F	1/2" - 3/4" NPT	Ductile iron, Cast iron
	1.2 M ³ /hr	10 Bar	up to 10,000 SSU	107°C		

F Series

A versatile high pressure pump commonly used to provide hydraulic power for positioning devices, lifts, and machine actuators. Well suited for liquid pressurization with fuel burners and blenders.



No. of Sizes	Theoretical Max Capacity	Differential Pressure	Viscosity	Max Temp.	Port Sizes	Housing Materials of Construction
13	403.2 GPM	425 PSI	Up to 22,000 cSt	212°/250°F	1/2" - 2 1/2" NPT	Cast Iron
	91.6 M ³ /hr	29 Bar	up to 100,000 SSU	100°/121°C	3" - 4" Flg	

2001 Type 10

This high pressure pump is rated at 1200 PSI while pumping 2-5 GPM. Used for low flow high pressure applications such as dosing injection and high pressure spray nozzles.



No. of Sizes	Theoretical Max Capacity	Differential Pressure	Viscosity	Max Temp.	Port Sizes	Housing Materials of Construction
1	2 GPM	1,200 PSI	Up to 110,000 cSt	350°F	3/4" - 3/8" NPT	Cast Iron
	.5 M ³ /hr	82.75 Bar	up to 500,000 SSU	176°C		

Progressing Cavity PC

Pulseless, low shear, solids handling pump for viscous and abrasive liquids. Commonly used in transferring wastewater sludge, polymers, grouts, paints and adhesives.



No. of Sizes	Theoretical Max Capacity	Differential Pressure	Viscosity	Max Temp.	Port Sizes	Housing Materials of Construction
15	1,000 GPM	750 PSI	Up to 10 million CPS	350°F	1" - 10" Flg plus hopper - 3/4" NPT	Stainless Steel, Cast Iron, Stator, Buna, Viton, EPDM, Nat. Rubber
	227 M ³ /hr	51.7 Bar	Up to 50 million SSU (approx.)	176°C		

Custom Engineered Products

With over 150 years of experience we have designed and developed numerous custom pumps for unique and demanding applications. Let us know what you need and our Engineers will design a pump specifically for you.

No. of Sizes	Theoretical Max Capacity	Differential Pressure	Viscosity	Max Temp.	Port Sizes	Housing Materials of Construction
-	1,200 GPM	1500 PSI	Up to 100,000 cSt	500°F	Various	Various
	272.5 M ³ /hr	103 Bar	up to 455,000 SSU	260°C		

Liquid Fuel Flow Dividers

Flow dividers for most sizes of liquid fuel fired gas turbines. Available in standard cast iron or stainless steel and bronze DuraFlow® versions.



- DuraFlow® Corrosion-Resistant Flow Dividers resist corrosion during standby, for reliable start-up of liquid fuel systems.
- DuraFlow® resists problems caused by fuel-borne particulate contamination.
- DuraFlow® offers dramatic savings on operation and maintenance.
- DuraFlow® is available new or retrofit, for most heavy industrial gas turbine makes and models.

Industry Pump Selection

This is a general guide and may not be relevant to your specific industry.
Review product selections and specific requirements with authorized representatives

Pressure and Flow

	Pressure PSI (Bar)	Max Flow GPM* ((M3/hr)
3600 Series	125 (8.6)	368 (1393)
Z Series	125 (8.6)	165 (625)
3800 Series	125 (8.6)	540 (2044)
9600 Series	100 (6.9)	165 (625)
Bulk Handling	125 (8.6)	1045 (3956)
5600 Series	100 (6.9)	232 (878)
A Series	300 (20.7)	75 (284)
2835 Series	75 (5.2)	11 (42)
ROC Series	300 (20.7)	32 (121)
V Series	150 (10.3)	5 (19)
F Series	425 (29.3)	403 (1526)
2001 Type 10	1200 (82.7)	2 (8)
Progressing Cavity	750 (51.7)	1000 (3785)
Custom Engineered Products	1500 (103.4)	1200 (4542)

Housing Materials of Construction

Cast Iron	Ductile	Steel	Stainless
ASTM A 48			
ASTM A 48			
ASTM A 48			
			CF-8M
ASTM A 48	ASTM A 395		
ASTM A 48			
ASTM A 48	ASTM A 395		
ASTM A 48	ASTM A 395		
			AISI 316
ASTM A 48	ASTM A 395		
ASTM A 48			
ASTM A 48			CF-8M
*		*	*
*	*	*	*

	Agriculture	Asphalt	Chemicals	Food & Beverage	Ink & Pigments	Marine	Mining	Oil & Gas	Personal Care	Pharmaceuticals	Power Generation	Pulp & Paper	Transportation	Wastewater
3600 Series	X	X		X	X			X			X	X	X	
Z Series	X	X		X	X			X			X	X		
3800 Series	X							X					X	
9600 Series	X		X						X	X		X	X	
Bulk Handling	X							X			X	X		
5600 Series	X							X					X	X
A Series	X				X			X			X			
2835 Series	X			X										
ROC Series	X		X		X			X	X	X				
V Series								X						
F Series								X			X			
2001 Type 10				X										
Progressing Cavity	X		X		X			X	X			X		X
Custom Engineered Products	X	X	X	X	X	X	X	X	X	X	X	X	X	X

Coro-Flo Pumps

Regenerative Turbine Liquid Pump

- Propane cylinder filling
- Bottle filling
- Stand-by systems
- Asphalt plants
- Autogas pumping
- Agricultural ammonia
- LP-Gas vaporizer feed



Coro-Vane Pumps

Sliding Vane Positive Displacement Liquid Pump

- Propane/butane bulk transfer
- Truck/delivery applications
- Barge unloading
- Tank/railcar unloading
- Agricultural ammonia



Side Channel Pumps

Multistage Regenerative Turbine Liquid Pump

- Propane/butane bulk transfer
- Carousel cylinder filling
- Multi-port butane bottle filling
- Barge unloading
- Tank/railcar unloading
- Agricultural ammonia

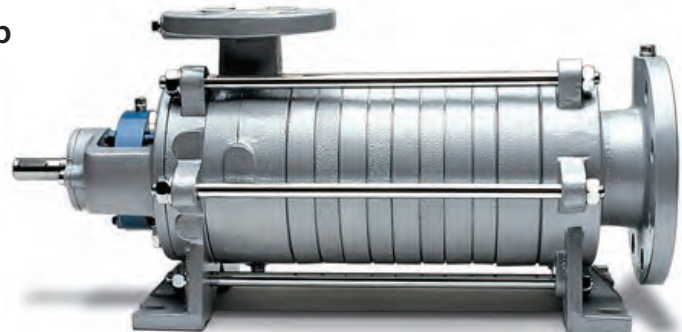

Coro-Flo Turbine Pumps

Regenerative Turbine Liquid Pump



The Coro-Flo® pump was designed for LPG, NH3 and other light liquids. For low-capacity, medium-head pumping, the Coro-Flo pump is the pump of choice. Extremely quiet and free of vibration and pulsation, the Coro-Flo pump provides trouble-free service and long life for volatile liquids such as LPG. The exclusive turbine construction provides smooth continuous flow through the pump case, resulting in higher efficiency and greater capacity and pressure for the same size motor. The one moving part, the impeller, floats on the shaft without contacting adjacent surfaces, thus extending pump life.

Specifications & Performance

Specifications	Model				
	9	10	12	13	14
Inlet	1- 1/4" NPT	1- 1/4" NPT	1- 1/2" NPT	1- 1/2" NPT	1- 1/2" NPT
Outlet	1" NPT	1" NPT	1" NPT	1" NPT	1" NPT
RPM-50 Hz RPM-60 Hz	(a) 3,450	2,880 3,450	2,880 3,450	2,880 3,450	2,880 3,450
Max. differential press. 50 Hz (bar) 60 Hz (bar)	- 70 (4.8)	60 (4.1) 70 (4.8)	75 (5.2) 100 (6.9)	75 (5.2) 125 (8.6)	75 (5.2) 125 (8.6)
Mounting options Close coupled Direct driven (101) V-belt (103)	Yes Yes Yes	Yes Yes Yes	Yes Yes Yes	Yes Yes Yes	Yes Yes Yes
Direct mounted frame (DS/DL)	Yes	Yes	Yes	Yes	Yes
Double seal option (except C-model)	Yes	Yes	Yes	Yes	Yes
Flange option 1-1/2" x 1" - 300# (except C-model)	Yes	Yes	Yes	Yes	Yes
Impeller material options	Bronze (standard), ductile iron, stainless steel				
O-ring material options	Buna N (standard), Neoprene®, Teflon®, Viton®, ethylene-propylene1				
Seal seat material opt.	Cast Iron (standard), Ni-Resist, stainless steel, tungsten carbide, ceramic				
Temperature (min./max.)	-25/225°F -32/107°C	-25/225°F -32/107°C	-25/225°F -32/107°C	-25/225°F -32/107°C	-25/225°F -32/107°C
Maximum driver	5 hp 3.7 kW	5 hp 3.7 kW	10 hp 7.5 kW	10 hp 7.5 kW	20 hp 15 kW

Coro-Vane Pumps

Regenerative Turbine Liquid Pump



The sliding-vane design of the Coro-Vane® pump is commonly found in the LPG industry because its pumping efficiencies remain high throughout the life of the pump. The Coro-Vane pump is unique because it can handle small amounts of vapor formed at the pump suction, and the vanes are self-adjusting for wear. With these design characteristics, pumping efficiencies remain high throughout the life of the pump.

Specifications & Performance

Specifications	Model			
	C51/F51	521	1021	F1021
Suction flange	1"	2-1/2"	3"	3" 300# ASA
Discharge flange	3/4"	2"	3"	2-1/2" 300# ASA
Minimum RPM	1,450	420	420	420
Maximum RPM	1,750	950	950	950
Minimum temperature	-25°F (-32°C)			
Maximum temperature	225°F (107°C)			
Max. working pressure psig (bar)	350 (25.2)	400 (28.6)	400 (28.6)	400 (28.6)
Max. differential pressure psig (bar)	125 (8.6)	125 (8.6)	125 (8.6)	125 (8.6)
Suction flange option	No	2"	4"	No
Discharge flange option	No	2-1/2"	4"	No
Internal relief	Yes	Yes	Yes	No
O-ring material options	Buna N (standard), Teflon®, Viton®, Neoprene®			
Seal seat material opt.	Cast iron (standard), stainless steel, Ni-Resist			
Steel slip-on flange option (suction & discharge)	No	Yes	Yes	No
Discharge flange option elbow (2" or 1-1/2")	No	Yes	No	No
Cast steel case option	No	Yes	No	No
Maximum driver	2 hp 1.5 kW	10 hp 7.5 kW	20 hp 15 kW	20 hp 15 kW

Side Channel Pumps

Multistage Regenerative Turbine Liquid Pump

The integral centrifugal and side channel design which characterizes this line provides a new dimension in liquid transfer applications. The SC-Series exceeds expectations in the handling of liquids involving high-differential pressures, low NPSH conditions, and aerated liquids up to 50% gas.

Six different sizes, each ranging from one to eight stages, provide solutions for a wide range of pressures, capacities, and liquid transfer requirements. Multiple material and sealing options, enabling it to handle many different liquids, enhance the versatility of the SC-Series.

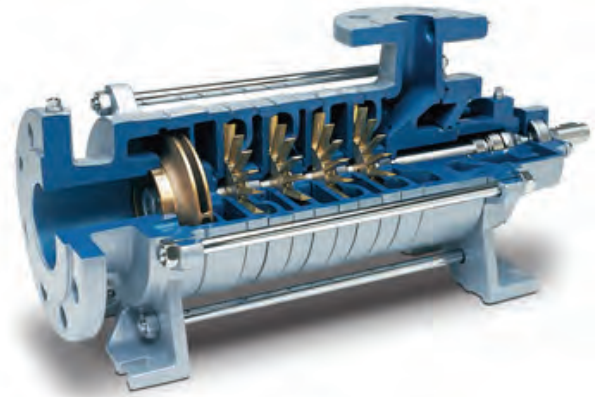

Specifications & Performance

Specifications	Model					
	10	20	30	40	50	60
Number of stages	1 to 8					
Inlet flange inches (mm)	1-1/2 (40)	2-1/2 (65)	2-1/2 (65)	3 (80)	4 (100)	4 (100)
Outlet flange inches (mm)	3/4 (20)	1-1/4 (32)	1-1/4 (32)	1-1/2 (40)	2 (50)	2-1/2 (65)
RPM-50 Hz RPM-60 Hz	1,450 1,750	1,450 1,750	1,450 1,750	1,450 1,750	1,450 1,750	1,450 1,750
Max. working pressure psig (bar)	580 (40)	580 (40)	580 (40)	580 (40)	580 (40)	580 (40)
Differential press. range psi (bar)	10 (.7)- 150 (10.3)	15 (1)- 230 (15.9)	10 (.7)- 180 (12.4)	10 (.7)- 175 (12.1)	10 (.7)- 210 (14.5)	10 (.7)- 250 (17.2)
Minimum temperature °F (°C)	-40° (-40°)	-40° (-40°)	-40° (-40°)	-40° (-40°)	-40° (-40°)	-40° (-40°)
Maximum temperature °F (°C)	428° (220°)	428° (220°)	428° (220°)	428° (220°)	428° (220°)	428° (220°)
NPSH range ft (m)	1.6 (.5)- 13 (4)	2 (.6)- 3.3 (1)	1.6 (.5)- 6.6 (2)	1.3 (.4)- 8.2 (2.5)	1.3 (.4)- 12 (3.5)	4.6 (1.4)- 8.2 (2.5)
Maximum viscosity SSU (cSt)	1,050 (230)	1,050 (230)	1,050 (230)	1,050 (230)	1,050 (230)	1,050 (230)
Maximum proportion of gas allowable	50%	50%	50%	50%	50%	50%
DIN flange option	Yes	Yes	Yes	Yes	Yes	Yes
ANSI flange option	No	Yes	Yes	Yes	Yes	Yes
Casing material option	Ductile iron (standard), cast iron, stainless steel					
Impeller material option	Brass (standard), steel, stainless steel					
O-ring material option	Viton® (standard), Teflon®, ethylene-propylene					
Double seal option	Yes	Yes	Yes	Yes	Yes	Yes
Magnetic drive option	Yes	Yes	Yes	Yes	Yes	No
High temp. option	Yes	Yes	Yes	Yes	Yes	Yes
Internal relief option	No	No	No	No	No	No

Vertical In-Line Self-Priming Centrifugal Pumps for Petroleums and Solvents

PUMP: Heavy-duty cast iron construction, with 2" NPT female threaded, in-line suction and discharge ports. This compact, vertical design is self-supporting and requires a minimum of floor space.

The self-priming feature allows the pump to be mounted above the liquid and suction lifts of 10' to 20' can be achieved, depending on the liquid and the pump model. Diffuser priming eliminates the need for a check valve and reduces radial loads insuring longer bearing life.

These pumps are sealed by a self-lubricating, Viton mechanical shaft seal. When used on a suction lift any leak-age that may occur will be down into the pump rather than up the motor shaft as the seal is on the suction side of the impeller.

MOTOR: Single phase motors are 60 cycle, 115/230 volt, except 2 HP explosion proof motors which are 230 volt only. Three phase motors are 60 cycle, 230/460 volt and all are 3450 RPM motors. All explosion proof motors are Class I, Group D, Code: T3B.

OPTIONAL MOUNTING: All models fit the Marlow Pumps lightweight, two wheel chassis. Kit illustrated in Section 800.

OPTIONAL SEAL: Kalrez mechanical seals are available. Contact us for more information.



Capacity in U.S. Gallons per Minute

Pump Model	Size	Total Head in Feet									
		10	20	30	40	50	60	70	80	90	100
20EVP	9A	—	112	93	72	23	—	—	—	—	—
	10A	—	—	63	58	51	36	12	—	—	—
	11A	—	103	94	84	72	55	15	—	—	—
	12A	—	115	108	100	90	78	65	41	—	—
	17A	—	121	120	116	110	102	91	77	60	32

Unit 608 and Unit 608-A

- Type: 0 Series, Self-Priming Centrifugal.
- Size: 2" x 2" (52 mm x 52 mm) with 1-1/2" (38 mm) Quick Disconnects.
- Pump Casing: Gray Iron 30.
- Maximum Operating Pressure 38 psi (262 kPa).*
- Enclosed Type Impeller: (Unit 608, Six Vane) or (Unit 608-A, Four Vane) Copper Alloy C83600.
- Handles 3/8" (9,5 mm) Diameter Spherical Solids.
- Impeller Shaft: Stainless Steel 416 (Provided with Motor).
- Replaceable Vane Plate: Gray Iron 30. Intermediate: Gray Iron 30.
- Gasket: Composition Cork w/Nitrile Binder.
- O-Ring: Fluorocarbon (DuPont Viton® or Equivalent).
- Hardware: Standard Plated Steel.



System Specifications

Eductor, Contamination Sight Gauge, Diverter Valve, Reel w/42' Long (12.8 m) Nitrile Cleanout Hose Assembly**, Stainless Steel 304 Standpipe (Guide Tube) Assembly, Motor Power Cable w/ Explosion-Proof On-Off Switch, Ground Wire, Two 1-1/2" x 15' Long (38 mm x 4.6 m) Suction/Discharge Recirculation Hoses w/Quick Disconnect Fittings.

Motor Specifications

Model	Type	Description	Hertz	Frame Size	Service Factor	Power	RPM	Voltage
Unit 608	x	Single Phase. Totally Enclosed, Fan Cooled, Explosion Proof. Thermal Overload Protection. Sealed Bearings. Capacitor Start/ Induction Run.	60	56	1.0	1 H.P.	3450	115
Unit 608-A	x		50			1.1 kW	2900	220

Seal Specifications

Type 21, Mechanical, Self-Lubricated. Carbon Rotating Face. Ni-Resist Stationary Face. Fluorocarbon Elastomers (DuPont VitonR or Equivalent). Stainless Steel 18-8 Cage and Spring. Maximum Temperature of Liquid Pumped, 160°F (71°C).

High-Flow Electric Vane Pumps



Model	M-3025-ML or -AL	M-3025CS-PO	M-3025-B100-ML or -AL
Part Number	133240-1 w/manual nozzle 133240-2 w/auto nozzle	133262-03 (Pump model)	133240-07 w/manual nozzle 133240-08 w/auto nozzle
Voltage Type	12-Volt DC - Vane	12-Volt DC - Vane	20
Flowrate	Up to 25 GPM (95 LPM)	Up to 25 GPM (95 LPM)	112
Duty Cycle	30 min. On / 30 min. Off	30 min. On / 30 min. Off	30 min. On / 30 min. Off
Power Cord	15 ft. (4.6m) of 10/3 AWG	15 ft. (4.6m) of 10/3 AWG	15 ft. (4.6m) of 10/3 AWG
Nozzle	Choice of manual or automatic shutoff.	None	Choice of manual or automatic shutoff.
Suction Pipe	None	—	121
Hose	12 ft. (3.7m) x 1 in.	None	12 ft. (3.7m) x 1 in.
Motor Protection	40 amp circuit breaker	40 amp circuit breaker	40 amp circuit breaker
Unique Feature	Highest flow, 12-volt pump, reduces time spent refueling.	Weight centering inlet base - includes check valve.	B100 Fuel requires a minimum operating temperature of 40°F.
Use With	Gasoline (alcohol blends E15), diesel fuel (biodiesel blends B20) and kerosene.	Gasoline (alcohol blends E15), diesel fuel (biodiesel blends B20) and kerosene.	Gasoline (alcohol blends E15), diesel fuel (biodiesel blends B100) and kerosene.
Approvals	Motor is U.L. Listed to U.S. and Canadian Standards	Motor is U.L. Listed to U.S. and Canadian Standards	Motor is U.L. Listed to U.S. and Canadian Standards
Warranty	2 Year	2 Year	2 Year

Emergency Fuel Cart System

PERFORMANCE / FEATURES:

12 volt Pump (M-3025CS)

- Flow (fully equipped) – 8 to 10 GPM with 14 foot suction height and 4 foot discharge height
- Flow (Pump only, no equipment) – Up to 25 GPM
- Suction – 10 in. Hg minimum.
- Bypass Pressure – 18 PSI (nominal)
- Integrated check-valve
- Duty Cycle – 30 minutes
- Approvals (motor) – cULus, listed “Electric Motor for Hazardous Locations”

Aluminum Meter (01A31GM)

- Flow Range – 3 to 30 GPM
- Accuracy – $\pm 5.0\%$ of reading
- Repeatability – $\pm .5\%$
- Pressure Rating – 300 PSI
- Pressure Drop – 1.7 PSI at 30 GPM
- Features – 1-inch NPT, 2 Totaling registers, Factory Calibrated
- Powered by two AAA batteries

Filter & Pump Inlet Strainer

- Replaceable (inline)
- Type 2, Hydrosorb II, for use with gasoline, diesel and alcohol blends of 10% or less
- 18 GPM flow rate capacity, 10 micron nominal filtration
- Strainer (pump inlet)
- 300 micron, 50 x 50 mes

Nozzle

- Automatic, Unleaded straight spout
- Equipped with attitude shut-off device
- U.L. Listed for use with gasoline, kerosene and fuel oils (number 1 & 2)

Discharge Hose

- 12 foot x 3/4", static wire, Nitrile (Goodyear Aggie Hose or equivalent), equipped with Cam/Groove connection



Suction Hose

- 22 foot x 3/4", static wire, Nitrile (Goodyear Aggie Hose or equivalent)
- Equipped with 8-inch x 3/4" aluminum tank-bottom standoff and 3/4" brass swivel

Power Cord

- 25 foot, 10/3 AWG, SOOW, 600V cable with 2 each 600-amp battery clamps

Riser

- Buna-N adapter for API fill-port attachment
- 12-inch x 1 1/2" PVC nipple
- 1 1/2" Strain Relief (Nylon, Nema-4X, 6 & 12, IP68, Buna-N seal)

Sump Cover

- 16-inch diameter x 3.8-inch domed, 1/8" thick HDPE (High Density Polyethylene) Buna-N grommet seal

Ground Wire

- 10 foot x 16 AWG wire with 48 Amp battery clamp

Emergency Fuel Tote System

PERFORMANCE / FEATURES:

12 volt Pump (M-3025CS)

- Flow (fully equipped) – 8 to 10 GPM with 14 foot suction height and 4 foot discharge height
- Flow (Pump only, no equipment) – Up to 25 GPM
- Suction – 10 in. Hg minimum.
- Bypass Pressure – 18 PSI (nominal)
- Integrated check-valve
- Duty Cycle – 30 minutes
- Approvals (motor) – cULus, listed “Electric Motor for Hazardous Locations”

Aluminum Meter (01A31GM)

- Flow Range – 3 to 30 GPM
- Accuracy – $\pm 5.0\%$ of reading
- Repeatability – $\pm .5\%$
- Pressure Rating – 300 PSI
- Pressure Drop – 1.7 PSI at 30 GPM
- Features – 1-inch NPT, 2 Totaling registers, Factory Calibrated
- Powered by two AAA batteries

Filter & Pump Inlet Strainer

- Replaceable (inline)
- Type 2, Hydrosorb II, for use with gasoline, diesel and alcohol blends of 10% or less
- 18 GPM flow rate capacity, 10 micron nominal filtration
- Strainer (pump inlet)
- 300 micron, 50 x 50 mes

Nozzle

- Automatic, Unleaded straight spout
- Equipped with attitude shut-off device
- U.L. Listed for use with gasoline, kerosene and fuel oils (number 1 & 2).

Discharge Hose

- 12 foot x 3/4", static wire, Nitrile (Goodyear Aggie Hose or equivalent), equipped with Cam/Groove connection



Suction Hose

- 14 foot x 3/4", static wire, Nitrile (Goodyear Aggie Hose or equivalent)
- One end equipped with 3/4" brass swivel

Power Cord

- 25 foot, 10/3 AWG, SOOW, 600V cable with 2 each 600-amp battery clamps

Riser

- Buna-N adapter for API fill-port attachment
- 12-inch x 1 1/2" PVC nipple
- 2" Cam/Groove connection to pump

Sump Cover

- 16-inch diameter x 3.8-inch domed, 1/8" thick HDPE (High Density Polyethylene) Buna-N grommet seal
- Buna-N grommet seal

Close-Coupled Centrifugal Pumps



LT Series



F/P Series



HP75 Series



**HP75
HP100 Series**



OH75 Series



MS50 Series



CD Series



RC Series



CL150 Series



XL/XT Series



XJ/JB Series



SP Series



XJ400 Pump

Air Operated Diaphragm Pumps



.25" AOD



.5"-.75" AOD



1" AOD



1.5" AOD



2" AOD



3" AOD

VDC Pumps

SD1202G Series



- Up to 13 GPM (49 LPM)
- 12 Volt
- Gasoline, Diesel, E15, Kerosene and B20 Compatible
- Heavy Duty Cast Iron
- Self-Priming Rotary Vane
- 8' Lift Capacity
- 1/4 HP Motor
- 30 Minute Duty Cycle
- Thermally Protected
- 1 Year Warranty

FR1210G Series



- Up to 15 GPM (57 LPM)
- 12 Volt
- Gasoline, Diesel, E15, Kerosene and B20 Compatible
- Heavy Duty Cast Iron
- Self-Priming Rotary Vane
- 8' Lift Capacity
- 1/4 HP Motor
- 30 Minute Duty Cycle
- Thermally Protected Motor
- 2 Year Warranty
- Also Available in 24 Volt - Model Number FR2410G

FR4210G Series



- Up to 20 GPM (75 LPM)
- 12 Volt
- Gasoline, Diesel, E15, Kerosene and B20 Compatible
- Heavy Duty Cast Iron
- Self-Priming Rotary Vane
- 8' Lift Capacity
- 1/4 HP Motor
- 30 Minute Duty Cycle
- Thermally Protected Motor
- 2 Year Warranty
- Also Available in 24 Volt - Model Number FR4410G

FR3210B Series



- Up to 25 GPM (94 LPM)
- 12 Volt
- Gasoline, Diesel, E15, Kerosene and BD up to B20 Compatible
- Powder-Coated Heavy Duty Cast Iron
- Self-Priming Rotary Vane
- 10' (Gasoline) 12' (Diesel) Lift Capacity
- 1/2 HP Motor
- 30 Minute Duty Cycle
- Thermally Protected Motor
- 2 Year Warranty

FR1210GARC Series



- Accessories Rated to -40°F (-40°C)
- Up to 15 GPM (57 LPM)
- Gasoline, Diesel, E15, Kerosene, and B20 Compatible
- Heavy Duty Cast Iron Construction
- Self-Priming Rotary Vane
- 15' Arctic Hose with Static Wire
- 3/4" Arctic Automatic Nozzle
- 3/4" Arctic Swivel
- 1/4 HP Motor
- Thermally Protected Motor
- 2 Year Warranty

VAC Pumps

SD602G Series



- Up to 13 GPM (49 LPM)
- 115 Volt
- Gasoline, Diesel, E15, Kerosene and B20 Compatible
- Heavy Duty Cast Iron
- Self-Priming Rotary Vane
- 8' Lift Capacity
- 1/4 HP Motor
- 30 Minute Duty Cycle
- Thermally Protected Motor
- 1 Year Warranty

FR610G Series



- Up to 15 GPM (57 LPM)
- 115 Volt
- Gasoline, Diesel, E15, Kerosene and B20 Compatible
- Heavy Duty Cast Iron
- Self-Priming Rotary Vane
- 8' Lift Capacity
- 1/4 HP Motor
- 30 Minute Duty Cycle
- Thermally Protected Motor
- 2 Year Warranty

FR700V/FR710V Series



- Up to 18 GPM (68 LPM)
- 115 Volt
- Gasoline, Diesel, E15, Kerosene and B20 Compatible
- Heavy Duty Cast Iron
- Self-Priming Rotary Vane
- 10' (Gasoline) 12' (Diesel) Lift Capacity
- 1/3 HP Motor
- 30 Minute Duty Cycle
- Thermally Protected Motor
- 2 Year Warranty
- Also Available in 230 Volt
- Model Number FR700VG

FR300V/FR310V Series



- FR300V: Up to 20 GPM (75 LPM)
- FR310V: 35 GPM (132 LPM)
- 115/230 Volt
- Diesel, Kerosene and B20 Compatible
- Heavy Duty Cast Iron
- Self-Priming Rotary Vane
- 18' Lift Capacity
- FR300V: 1/2 HP FR310V: 3/4 HP Motor
- 30 Minute Duty Cycle
- Thermally Protected Motor
- 2 Year Warranty

FR700VARC Series



- Accessories Rated to -40°F (-40°C)
- Up to 20 GPM (75 LPM)
- Gasoline, Diesel, E15, Kerosene, and B20 Compatible
- Heavy Duty Cast Iron
- Self-Priming Rotary Vane
- 3/4" x 15' Arctic Hose with Static Wire
- 3/4" Arctic Automatic Nozzle
- 3/4" Arctic Swivel
- 1/3 HP Motor
- Thermally Protected Motor
- 2 Year Warranty

Hand Pumps

FR112 Series



- 10 Gal. (37 Liters) Per 100 Revolutions
- Vacuum Breaker
- Gasoline, Diesel, E15, Kerosene, Light Oils and B20 Compatible
- Pail or Nozzle Spout
- Perfect for Tank or Drum Mounting
- UL Certified
- 2 Year Warranty

FR152 Series



- 20 Gal. (75 Liters) Per 100 Strokes
- Vacuum Breaker
- Gasoline, Diesel, E15, Kerosene, Light Oils and B20 Compatible
- Pail or Nozzle Spout
- Perfect for Tank or Drum Mounting
- UL Certified
- 2 Year Warranty

FR156



- 20 Gal. (75 Liters) Per 100 Strokes
- Includes 807C flow meter
- Vacuum Breaker
- Gasoline, Diesel, E15, Kerosene, Light Oils and B20 Compatible
- Perfect for Tank or Drum Mounting
- UL Certified
- 2 Year Warranty

FR31



- 1 Quart (.95 Liters) Per Stroke
- Return Drip Tube
- Diesel, E15, Kerosene, Oil and B20 Compatible
- Built in Check Valves
- 2 Year Warranty

SD62



- 7.5 Gal. (28 Liters) Per 100 Revolutions
- Pail Spout
- Diesel, E15, Kerosene, B20 and Light Oils Compatible
- Tank or Barrel Mounting
- 1 Year Warranty

FR20V



- 11 oz. (.32 Liters) Per Stroke
- Ready for Tank or Drum Mounting
- ATF Fluids, Motor Oils Compatible
- 1 Year Warranty

SD11



- 11 oz. (.32 Liters) Per Stroke
- 1" or 1.5" Bung Threads
- Non-Drip Spout w/ Garden Hose Threads
- Ready for Tank or Drum Mounting
- 1 Year Warranty

Complete Systems

FR1211G

- Up to 13 GPM (49 LPM)
- 12 Volt Thermally Protected Motor
- Gasoline, Diesel, E15, Kerosene and B20 Compatible
- Heavy Duty Cast Iron
- Self-Priming Rotary Vane
- 8' Lift Capacity
- 1/4 HP Motor
- 30 Minute Duty Cycle
- 807 Mechanical Meter
- Manual Nozzle and 12' Hose
- 2 Year Warranty



FR4211G

- Accessories Rated to -40°F (-40°C)
- Up to 20 GPM (75 LPM)
- Gasoline, Diesel, E15, Kerosene, and B20 Compatible
- Heavy Duty Cast Iron
- Self-Priming Rotary Vane
- 3/4" x 15' Arctic Hose with Static Wire
- 3/4" Arctic Automatic Nozzle
- 3/4" Arctic Swivel
- 1/3 HP Motor
- Thermally Protected Motor
- 2 Year Warranty



FR4210GBFQ

- Up to 17 GPM (64 LPM)
- 12 Volt Thermally Protected Motor
- Gasoline, Diesel, E15, Kerosene and B20 Compatible
- Heavy Duty Cast Iron
- Self-Priming Rotary Vane
- 8' Lift Capacity
- 1/4 HP Motor
- 30 Minute Duty Cycle
- Ultra High Flow Automatic Nozzle and 20' Hose
- Heavy Duty Power Cable w/ Alligator Clips
- Particulate Filter
- 2 Year Warranty



FR711VA

- Up to 18 GPM (68 LPM)
- 115 Volt Thermally Protected Motor
- Gasoline, Diesel, E15, Kerosene and B20 Compatible
- Heavy Duty Cast Iron
- Self-Priming Rotary Vane
- 10' (Gasoline) 12' (Diesel) Lift Capacity
- 1/3 HP Motor
- 30 Minute Duty Cycle
- Ultra High Flow Automatic Nozzle and 18' Hose
- 901 Mechanical Meter
- 2 Year Warranty



FR319VB

- Up to 27 GPM (102 LPM)
- 115/230 Volt Thermally Protected Motor
- Diesel, Kerosene and B20 Compatible
- Heavy Duty Cast Iron
- Self-Priming Rotary Vane
- 18' Lift Capacity
- 3/4 HP Motor
- 30 Minute Duty Cycle
- Ultra High Flow Automatic Nozzle and 18' Hose
- 900DB Digital Meter
- 2 Year Warranty



Meter Dispensers

FR902DP FR302DP Series

- Up to 40 GPM (151 LPM)
- 50 psi (3.4 bar)
- 115/230V Input
- Diesel Fuel Only
- Includes: 4 Digit 900DP Meter, Hammer Arrestor and Standard UL Nozzle Boot
- 2" NPT Inlet, 1" NPT Outlet
- ± 1.25% Accuracy
- ± 0.25% Repeatability
- Field Calibration
- FR302DP: Includes FR310 Pump Shown with Optional Pedestal Kit KITPD and Optional Ultra High Flow Nozzle



FR910 Series

- 4-40 GPM (15-151 LPM)
- 50 psi (3.4 bar)
- 115V Input
- Diesel Fuel Only
- Includes: TS10A Oval Gear Meter, Hammer Arrestor and Standard Nozzle Boot
- 2" NPT Inlet, 1" NPT Outlet
- ± 0.3% Accuracy
- ± 0.15% Repeatability
- Field Calibration

Shown with Optional Pedestal Kit KITPD and Optional Ultra High Flow Nozzle



FR102PH Series

- 50 psi (3.4 bar)
- 115/230V Input
- 1" NPT Inlet, 1" NPT Outlet
- Includes: Nozzle Hook
- Shown with Optional Ultra High Flow Nozzle



Nozzles

- 3/4" and 1" Manual Nozzles
- 3/4" Automatic Unleaded Nozzle
Standard and Arctic Models Available



Swivels

- 3/4" and 1" Multiplane Plane Swivels



- 3/4", 1" High Flow Diesel Nozzles 1" Ultra High Flow and 1" Arctic Model Available



Hoses

- 3/4" x 12', 14', 20' Hose w/ Static Wire
- 1" x 12', 14', 20' Hose w/ Static Wire
- 3/4" x 15', 1' x 20' Arctic Hose w/ Static Wire



N990

- Bronze Corrosion Resistant Castings
- Special Cast Bronze Gears
- Stainless Steel Shafts & Fasteners
- Formed Ring Seal Packing (Lip & Mechanical Seals on Special Order)
- Heavy Duty Carbon Bearings (Self Lubricating)
- Positive Displacement Flow

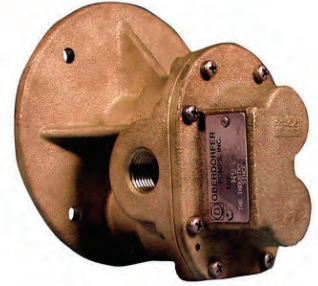

N1000

- Up to 15 GPM (57 LPM)
- 115 Volt
- Gasoline, Diesel, E15, Kerosene and B20 Compatible
- Heavy Duty Cast Iron
- Self-Priming Rotary Vane
- 8' Lift Capacity
- 1/4 HP Motor
- 30 Minute Duty Cycle
- Thermally Protected Motor
- 2 Year Warranty

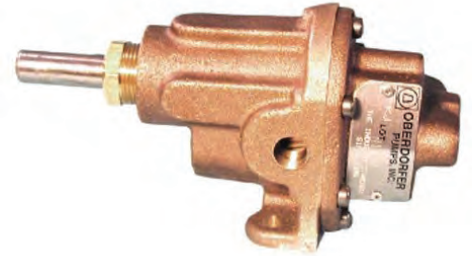

N2000

- Up to 18 GPM (68 LPM)
- 115 Volt
- Gasoline, Diesel, E15, Kerosene and B20 Compatible
- Heavy Duty Cast Iron
- Self-Priming Rotary Vane
- 10' (Gasoline) 12' (Diesel) Lift Capacity
- 1/3 HP Motor
- 30 Minute Duty Cycle
- Thermally Protected Motor
- 2 Year Warranty
- Also Available in 230 Volt
- Model Number FR700VG

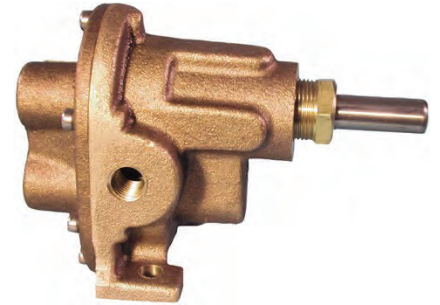

N3000

- FR300V: Up to 20 GPM (75 LPM)
- FR310V: 35 GPM (132 LPM)
- 115/230 Volt
- Diesel, Kerosene and B20 Compatible
- Heavy Duty Cast Iron
- Self-Priming Rotary Vane
- 18' Lift Capacity
- FR300V: 1/2 HP FR310V: 3/4 HP Motor
- 30 Minute Duty Cycle
- Thermally Protected Motor
- 2 Year Warranty

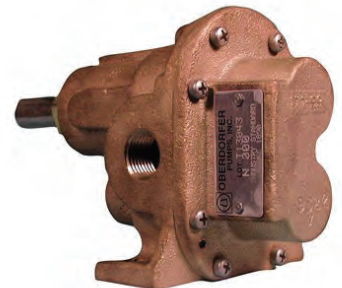



COMPRESSORS



Vertical Air Compressor

Vertical electric motor mounted air compressors can be mounted on 60, 80, and 120 gallon tanks and rank among the best industrial air compressors in the industry.

Motor HP	ASME Tank Size	Splash Lubricated Model	Pressure Lubricated Model	Pump RPM	CFM Displaced @175 psi	CFM Delivered @175 psi	Shipping Weight
1.5	60	VT-715-60	VT-PL-715-60	400	7.8	5.8	522
2	60	VT-720-60	VT-PL-720-60	510	10	7.5	543
3	80	VT-730-80	VT-PL-730-80	540	14.8	11.1	632
5	80	VT-735-80	VT-PL-735-80	845	23	17.3	648
7.5	80	VT-745-120	VT-PL-745-120	655	35.4	26.9	915
10	120	VT-755-120	VT-PL-755-120	845	46	34.4	935



Industrial Air Compressor

Two Stage Reciprocating Models

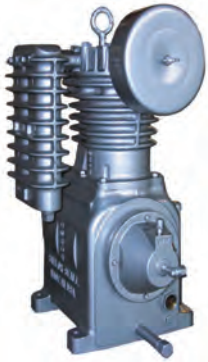

Model 703-705



Model 707



Model 4500

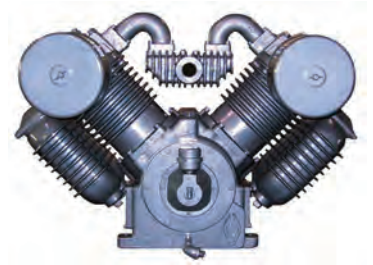

Model 9000

Motor HP	Splash Lubricated Model	Pressure Lubricated Model	Pump RPM	CFM Displaced @175 psi	CFM Delivered @175 psi	Shipping Weight
1.5-2	703	PL-703	510	10	7.5	213
3-5	705	PL-705	845	23	17.3	219
5-10	707	PL-707	845	46	34.4	338
10-15	4500	PL-4500	830	63.7	51	469
15-30	9000	PL-9000	830	127.4	101.9	666

Rotary Screw Air Compressors

- 5 - 350 hp
- Quiet & Reliable
- 24-hour operation
- Precision-crafted rotors
- Triplex bearings



Reciprocating Piston

- 3 - 30hp
- Gas and electric
- Over 90 years of proven quality



Air Treatment

- Refrigerated & Desiccant dryers
- Filters
- Coalescers
- Drains
- Mist eliminators



Compressor Parts & Fluid

- Fluid
- Filters & Separators
- Elements
- Gaskets/seals
- Valves/rods



Natural Gas Compressors

- 2 - 600 hp
- Single & two-stage reciprocating
- Direct drive rotaries
- Over 20 models

Vacuum Pumps

- Delivers the most acfm per brake hp
- Zero-to-max full flow capabilities
- Quiet pump



Krug Vapor Compressor

- Economical way in which to transfer, evacuate or purge tanks
- Environmentally friendly, once the connections are made it is a closed loop system with little chance of leaks
- Save your truck pump from damages use this unit for evacuating tanks
- Capacity 18 to 50 GPM depending on piping

Engine Specs

- 4hp overhead valve Honda engine
- Spark arresting muffler
- Shielded electronic ignition
- On-Off switch
- Available with Gasoline or LP carburetion

Compressor Specs

- 2 cylinder 10.7 cu. in. displacement
- Suction port 1/2 in. fmpt
- Discharge port 1/2 in. fmpt with pressure gauge
- 1000 rpm

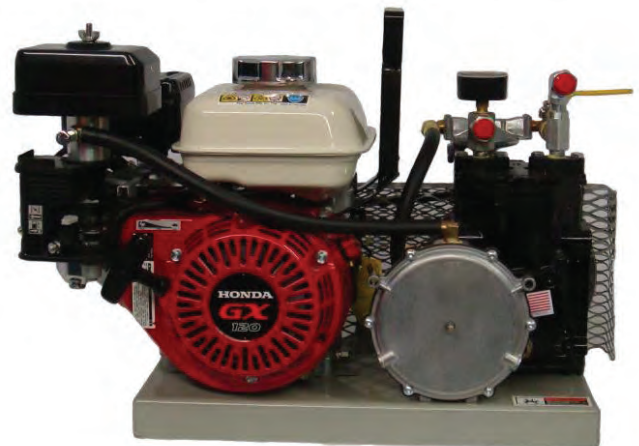

Liquified Gas Compressors



LB601

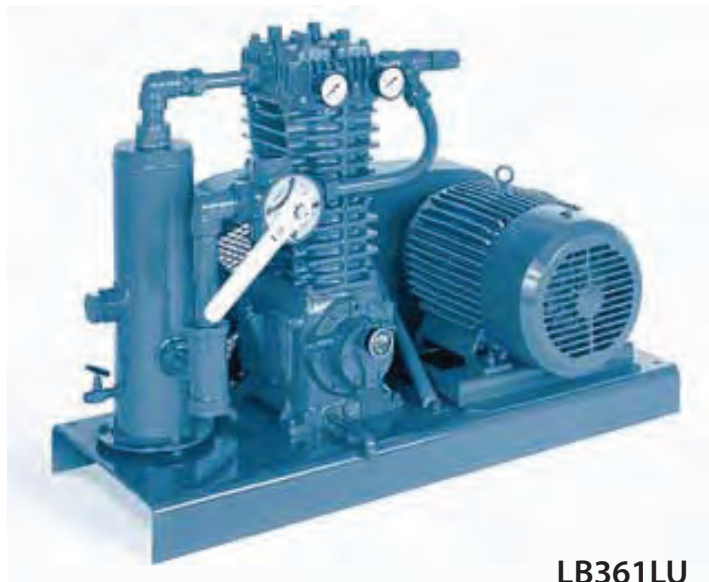

LB361LU

	Compressor Model			
	LB161 LB162	LB361 LB362	LB601 LB602	LB942
Bore - Inches (mm)	3.0 (76.2)	4.0 (101.6)	4.625 (117.4)	4.625 (117.4)
Stroke - Inches (mm)	2.5 (63.5)	3.0 (76.2)	4.0 (101.6)	4.0 (101.6)
Piston Displacement CFM (m3/h) @ 100 rpm	2.0 (3.4)	4.3 (7.3)	7.7 (13.1)	14.9 (25.38)
@ 825 rpm	16.5 (28.0)	35.5 (60.3)	63.5 (107.9)	123 (209)
Compressor Speed Minimum rpm	350	350	350	350
Maximum rpm	825	825	825	825
Maximum Working Pressure - psia (Bar)	350 (24.13)	350 (24.13)	350 (24.13)	350 (24.13)
Maximum Brake Horsepower (kw)	7.5 (6)	15 (11)	40 (30)	50 (37)
Max. Discharge Temperature °F (°C)	350 (177)	350 (177)	350 (177)	350 (177)
Max. Compression Ratio Continuous Duty 2	5	5	5	5
Intermittent Duty 2	9	9	9	9

Model	Speed	Approximate Liquid Transfer Delivery ¹		Piston Displacement		Driver Size ²		Pipe Diameter			
		RPM	U.S. GPM	LPM	CFM	M ³ /H	HP	KW	Vapor		Liquid
								in.	mm	in.	mm
LB161 LB162	425	49	186	8.5	14.4	3	2	1	25	2	50
	560	65	246	11.2	19.0	5	4				
	715	83	314	14.3	24.3	5	4	1 1/4	32		
	780	90	341	15.6	26.5	7.5	6				
	810	92	348	16.2	27.5	7.5	6				
LB361 LB362	495	123	466	21.3	36.2	7.5	6	2 1/2	65		
	540	134	507	23.2	39.5	10	7				
	650	161	609	28.0	47.5	10	7	1 1/2 - 2	38-50	3	80
	780	194	734	33.5	57.0	15	11				
	810	201	761	34.8	59.1	15	11				
LB601 LB602	545	242	916	42.0	72.0	15	11	2 - 2 1/2	50-65	4	100
	655	288	1,090	50.6	85.9	20	15				
	755	335	1,268	58.7	99.8	25	19				
	800	355	1,344	62.2	105.7	30	22				
LB942	470	400	1,514	70	119	25	19	3 - 4	76 - 102	6	152
	565	480	1,817	84	143	30	22				
	750	640	2,422	112	190	40	30				
	800	680	2,575	119	202	50	37				

Liquid Gas Transfer Compressor Applications

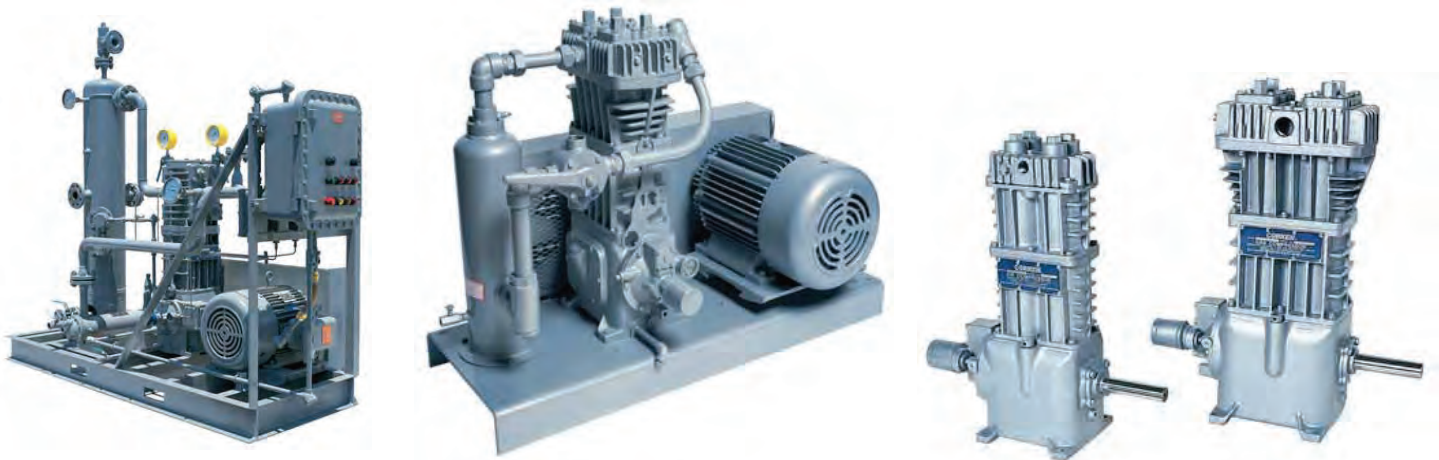

.....

The "107" bulk plant gas compressor unit is complete with pressure gauges, steel baseplate, mechanical liquid trap, four-way valve, strainer, interconnecting piping, adjustable driver-slide-base, v-belt drive and beltguard ready to receive an electric motor. This standard unit is typically used for liquid transfer and vapor recovery in applications including rail car and truck loading and unloading. Many options such as ASME liquid traps with Class 1, Group D switches and total engineered packages can be provided.

The D891 and HG601 series compressors are for high-volume transfer applications with flow capacities from 337 to 1552 gpm (76.5 to 352.5 m³/hr). These compressors are available in standard mounting configurations and also in special-engineered packages which include safety shutdowns and controls as required.

The "102" compressor comes complete with extended crankshaft for utilization on trucks with PTO and hydraulic drive systems. The compressor can be used for loading/unloading as well as vapor recovery on trucks.

Specifications	Model						
	91	291	491	691	891 (a)	HG601BB (b)(e)	HG601AA (b)(e)
Bore of cylinder Inches (mm)	3.0 (76.2)	3.0 (76.2)	4.0 (101.6)	4.5 (114.3)	4.5 (113)	6 (152)	8 (203)
Stroke: Inches (mm)	2.5 (63.5)	2.5 (63.5)	3.0 (76.2)	4.0 (101.6)	4.0 (101.6)	3 (76.2)	3 (76.2)
Piston displacement CFM (m ³ /hr)	4.0 (6.8)	8.0 (13.6)	17.2 (29.2)	29.2 (49.6)	56.6 (96.2)	76.8 (130.5)	138 (234.5)
minimum @ 400 RPM	8.3 (14.1)	16.5 (28.0)	35.5 (60.3)	60.2 (102.3)	113.2 (192.0)	-	-
maximum @ 825 RPM	-	-	-	-	-	230.5 (391.9)	413.8 (703.5)
maximum @ 1,200 RPM	-	-	-	-	-	-	-
Maximum working pressure: psig (bar)	350 (24.1)	350 (24.1)	350 (24.1)	350 (24.1)	465 (32.1)	365 (25.2)	315 (21.7)
Maximum brake horsepower (kW)	7.5 (5.6)	15 (11)	15 (11)	35 (26.1)	45 (34)	75 (55.9)	75 (55.9)
Maximum rod load lb (kg)	3,600 (1,632.9)	3,600 (1,632.9)	4,000 (1,814.4)	5,500 (2,494.8)	7,000 (3,175.2)	7,000 (3,175.2)	7,000 (3,175.2)
Maximum outlet temperature °F (°C)	350 (177)						
Bare unit weight lb (kg)	115 (52.2)	160 (72.6)	260 (117.9)	625 (283.5)	855 (387.8)	828 (375.6)	868 (393.7)
Maximum flow-propane gpm (m ³ /hr)	50 (11.4) (c)	101 (22.9) (c)	215 (48.8) (c)	361 (82.0) (c)	694 (157.6) (c)	1,305 (296.4) (e)	1,725 (391.8) (f)
ANSI/DIN flange option	F91	F291	F491	F691	(d)	(d)	(d)

(a) Double-acting vertical compressor

(b) Double-acting horizontal compressor

(c) Maximum flow is based on 825 RPM or maximum hp, 30 psid. Capacities shown are based on 100 °F (37.8 °C) and will vary depending upon piping, fittings, product being transferred, and temperature. The factory will supply a detailed compressor analysis if required.

(d) Not available

(e) Maximum rating at 1,200 RPM

(f) Maximum is based on hp limit and 845 RPM

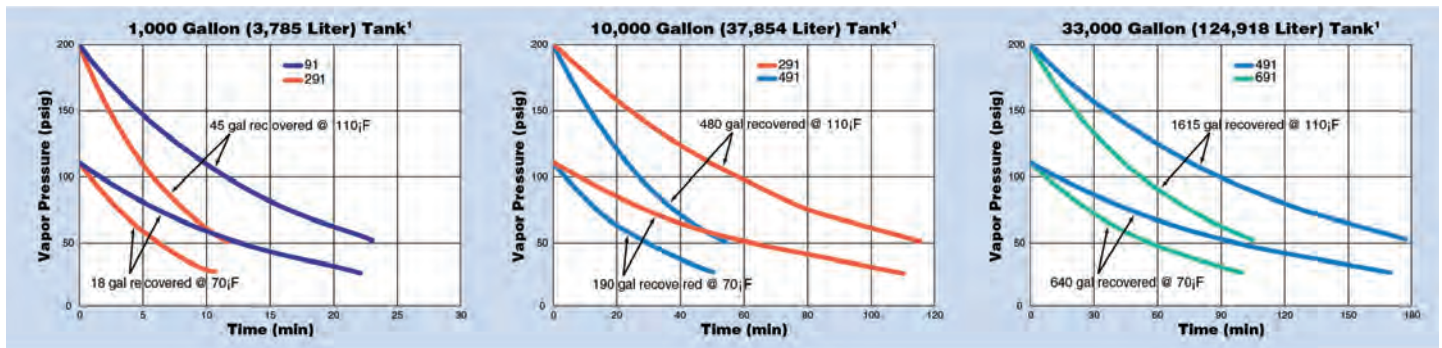



VALVES



Flanged Gate Valves



Cast Steel
Cast Stainless Steel
150#, 300# & 600#

Flanged Globe Valves



Cast Steel
Cast Stainless Steel
150#, 300# & 600#

Flanged Check Valves



Cast Steel
Cast Stainless Steel
150#, 300# & 600#

Flanged Full Port Ball Valve



Full port
Class 150
Locking device
Blow-out proof stem
NACE MR-0175

2 Piece Ball Valve



Full port
1000 WOG
316 Stainless Steel
Locking device
Blow-out proof stem
Oval handle available



Actuators & Controls



APOLLOXPRESS



Automatic Control Valves



Backflow Preventers



Balancing Valves



Ball Valves



Butterfly Valves



Check Valves



Medical Gas Valves



Mixing Valves



Needle Valves



PEX / Wholesale



Water Pressure Reducing Valves



Pipeline Strainers



Plumbing & Heating



PUSH



Safety Relief Valves

Thread Sealant



W.O.G. Plus

Jomar's W.O.G Plus is a fast drying, hard setting, semi-paste, thread and gasket sealer. It remains flexible, so vibrations will not loosen connection. W.O.G plus seals tightly but allows for disassembly without damage to parts. It is lead free, halogen free, non-corrosive and nontoxic.

The Heavyweight

Jomar's Heavyweight is a slow drying, soft setting, non-hardening industrial PTFE pipe thread compound. It will not transfer taste or odor to the system being sealed. Excellent for food and water systems. It is lead free, anti-galling, non-corrosive, nontoxic, and will not harden in can.

Gimmie The Green Stuff

Jomar's Green Stuff is a slow drying, soft setting, non-hardening pipe thread compound. It will not transfer taste or odor to the system being sealed. Excellent for food and water systems. It is lead free, anti-galling, non-corrosive, nontoxic, and will not harden in can.

Gimmie The White Stuff

Jomar's White Stuff is a slow drying, soft setting, non-hardening PTFE pipe thread compound. It will not transfer taste or odor to the system being sealed. Excellent for food and water systems. It is lead free, anti-galling, non-corrosive, nontoxic, and will not harden in can.

Hi-Temp

Jomar's Hi-Temp is a copper based anti-seize lubricant and thread sealant. It produces a permanent leak-proof metallic seal under pressure, yet prevents seizing, galling, freezing, and tearing, even under extreme conditions. It is lead free, non-corrosive, nontoxic, and will not harden in can.

Acids, Diluted	Freon (All)	Naphtha
Air, Compressed Gaseous	Gasoline*	Natural Gas
Alkalis Diluted	Gasohol	Nitrogen, Gaseous
Ammonia	Glycol	Oxygen
Aliphatic Solvents	Heating Oils	Petroleum Solvents
Brine	Helium Gaseous	Propane
Butane	Hydraulic Oils	Refrigeration Gases
Carbon Dioxide	Hydrogen	Soap, Liquid
Castor Oils	Inert Gasses, Gaseous	Steam Lines
Chlorinated Water	Jet Fuel (JP 3,4,5)	Sugar, Liquid
Corrosives	Kerosene	Vegetable Oils
Coal Tar Naphtha	Lacquer	Water (Hot or Cold)
Cutting Oils	Liquefied Petroleum Gases	Xylol
Diesel Fuel Oil	Manufactured Gases	Sodium Hypochlorite
Fatty Acids (Liquids)	Mineral Oils	

*Contact Jomar for compatible blends

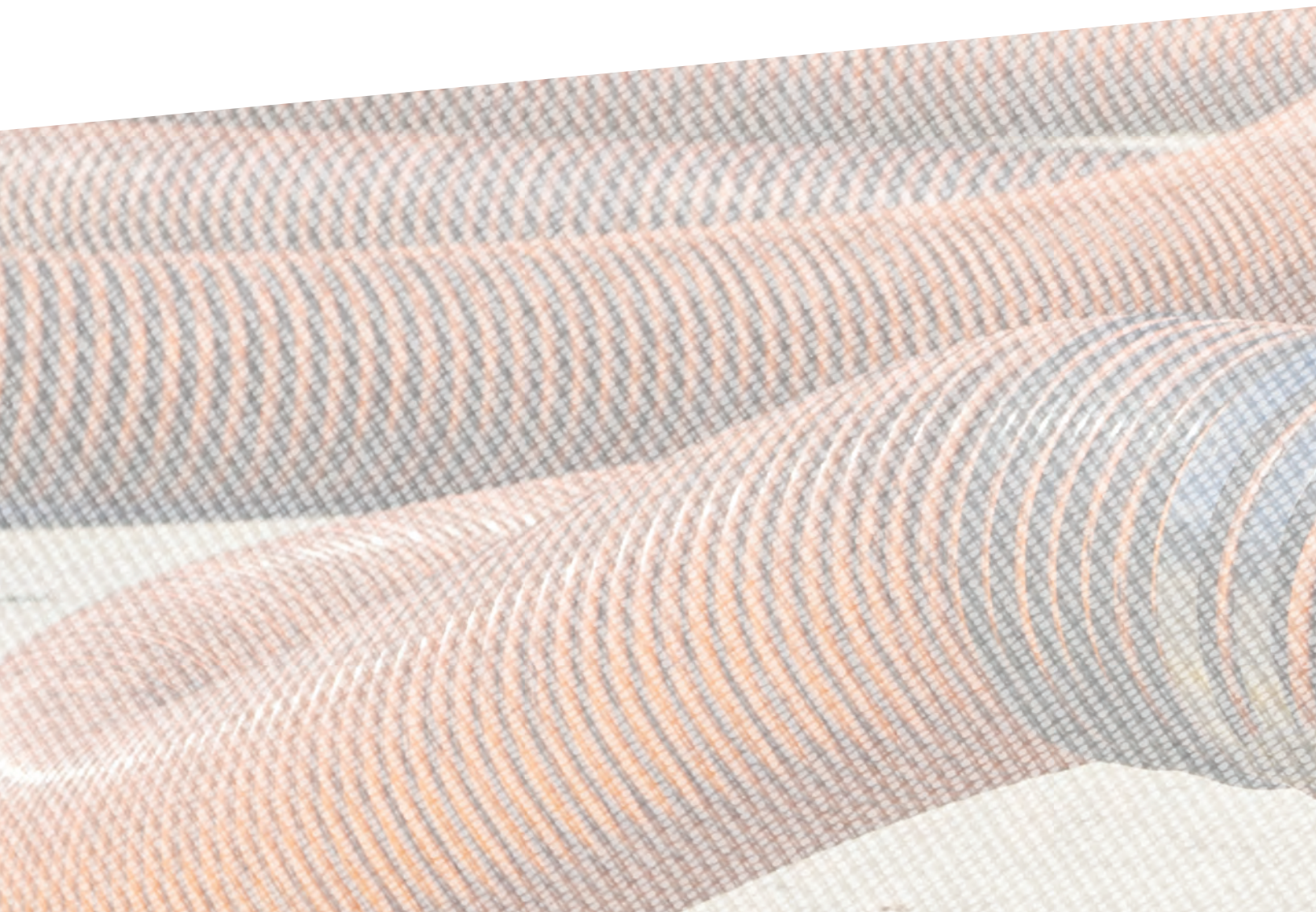

SERVICE STATION EQUIPMENT



OPW FlexWorks Piping Layout (Pressure System)

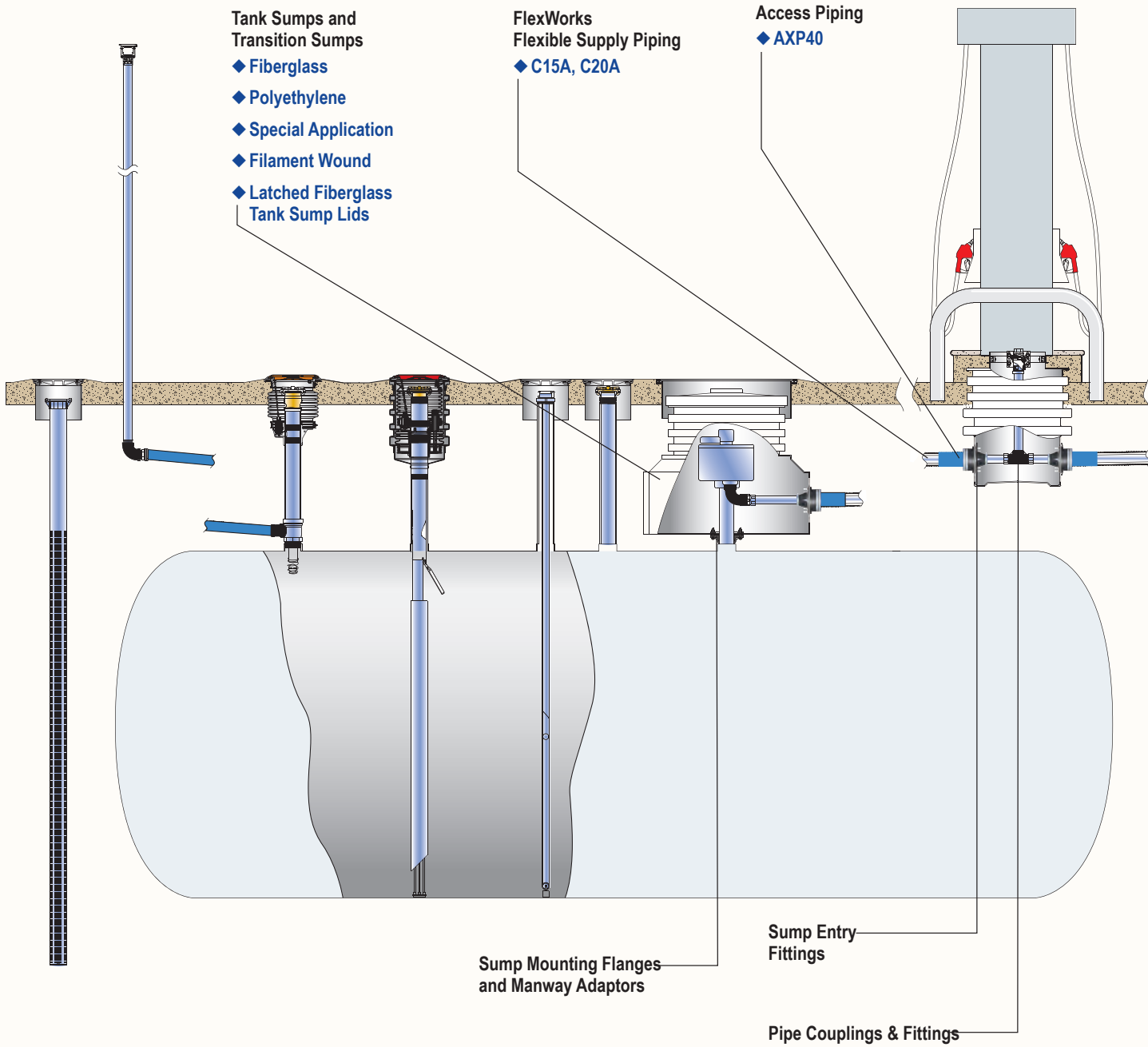

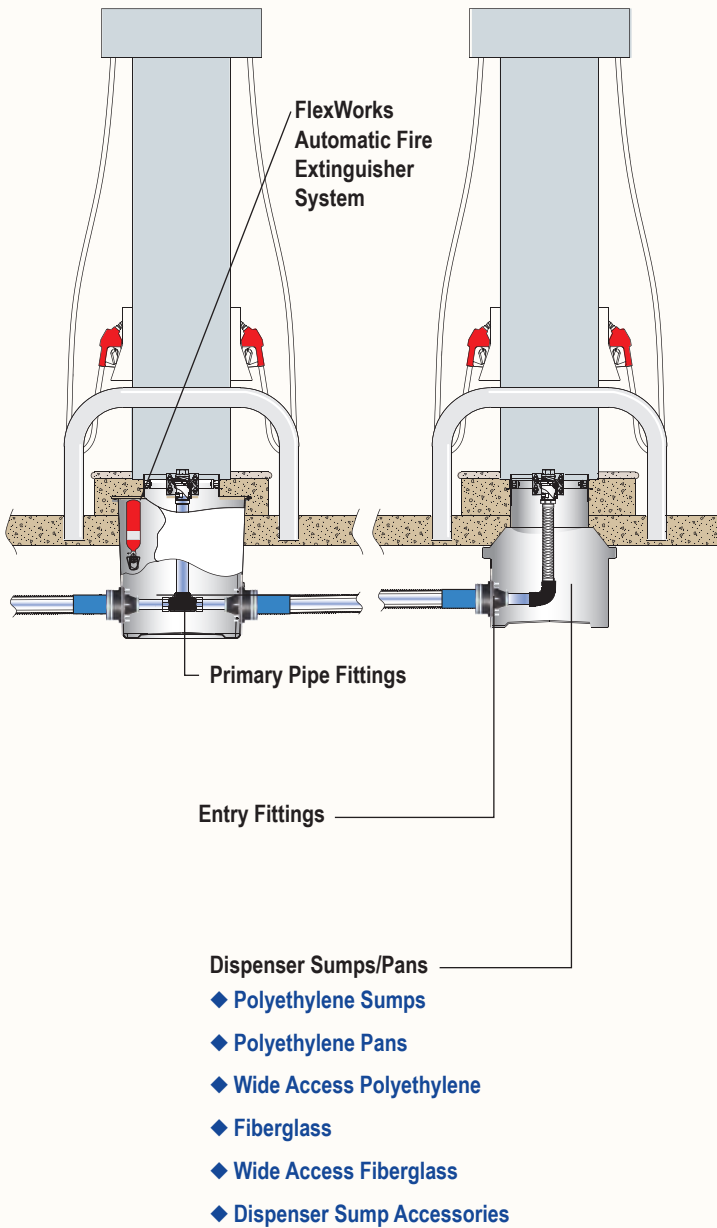

OPW Fueling Containment Systems

Innovative Fueling Solutions

The heart of FlexWorks is an advanced, flexible piping system that can be installed quickly and easily in a variety of configurations. Flexible piping eliminates the need for buried piping joints, which are notorious leak points in rigid piping systems. In a pressure system, the submersible pump is connected in series directly to the dispensers with a continuous run of flexible pipe. In a suction system, a continuous run of flexible pipe connects the tank to the suction pump dispenser. All piping connections at the tank and dispensers are contained in sumps.

The primary fuel pipe is available with an integral secondary containment pipe, which can be inserted into a lined, corrugated access pipe. The crush-resistant access pipe protects the primary pipe from the backfill while serving as an added layer of protection. The access pipe also affords the added advantage of primary pipe retractability. Future inspection, repair or replacement of the primary pipe is achievable without excavation.

The FlexWorks System features highly integrated components that interconnect seamlessly to provide reliable Secondary Containment. FlexWorks dispenser sumps are custom made for each particular dispenser footprint. FlexWorks tank sumps afford raintight containment for and accessibility to submersible pumps and UST equipment. A variety of FlexWorks entry fitting styles and sizes ensure the availability of a custom-designed solution for virtually every piping application.

FlexWorks by OPW Fueling Containment Systems are the complete Environmental System for underground fuel transfer and containment for the 21st century.

Above Ground Storage Tank - Direct Fill Typical Non-EVR Direct Fill AST Application

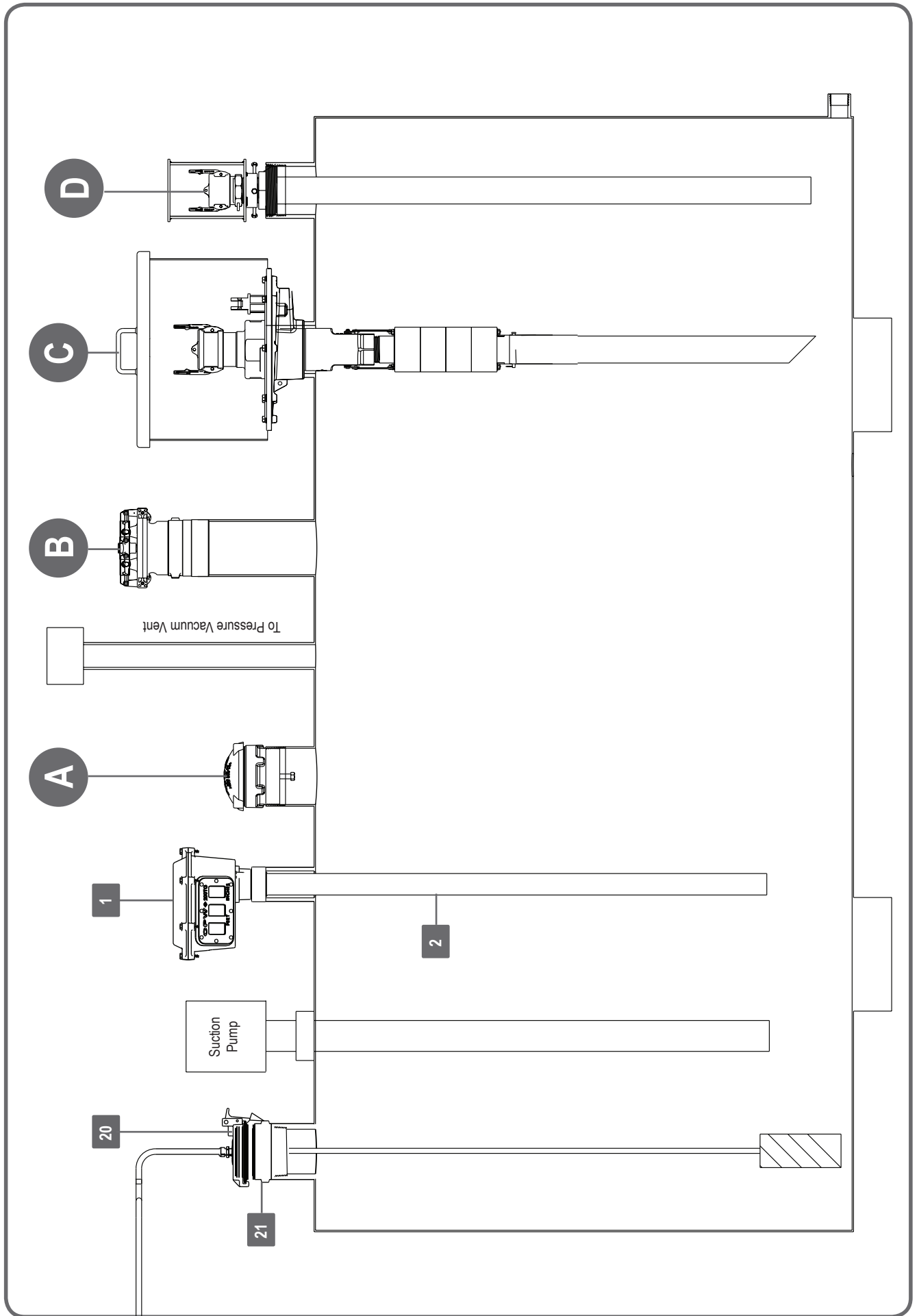

PRODUCT KEY

	OPW PART / DESCRIPTION	PAGE
1	200TG-ENG Series Tank Gauge (optional / see Note below)	252
2	61T Series Drop Tube	128
3	301 Series Emergency Vent - NPT Mount (See Vent Size Configuration Guide on page 244)	254
4	301 Series Emergency Vent - Flanged Mount (See Vent Size Configuration Guide on page 244)	254
5	1711T-7085-EVR Cap	113
6	1611AV Series Vapor Recovery Adaptor	112
7	1711LPC-0300 Low Profile Cap	113
8	61VSA Series Vapor Recovery Adaptor	111
9	190 or 210 High-Flow Bulk Nozzle	214 & 218
10	633BD Kamlok™ Coupler	250
11	A) 634B-0150 Dust Cap or 634BK-0090 Lockable Dust Cap fits 633AST-2061 Spout Adaptor B) 634B-0170 Dust Cap or 634BK-0100 Lockable Dust Cap fits 633AST-3061 Spout Adaptor	250
12	633AST-2061 (2" x 2") or 633AST-3061 (3" x 3") - Tank Inlet Spout Adaptor	250
13	331 or 332 Series Spill Container	246
14	61FSTOP-XXXX Series Overfill Prevention Valve	248-249
15	61FT Series Drop Tube	249
16	634B-0150 or 634BK-0090 Cap	250-251
17	204247 Fill Prevention Cage	250
18	633AST-2190 Adaptor	250
19	53-00XX Series Double Tapped Bushing	142
20	62M Series Monitoring Probe Cap & Adaptor	127
21	FSA-400 Face Seal Adaptor	59

NOTE: The OPW 200TG and 144TA/444TA are not required for EVR compliance, but if a tank gauge or tank alarm is used on your tank that these two OPW products are the only CARB AST EVR certified tank gauge and alarm.

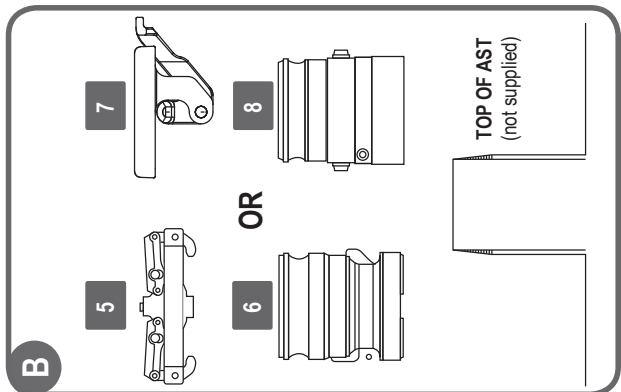
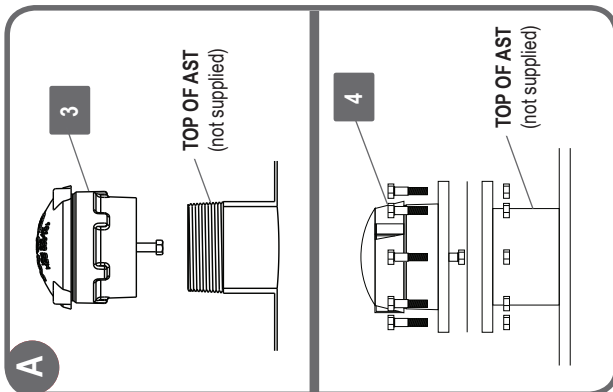
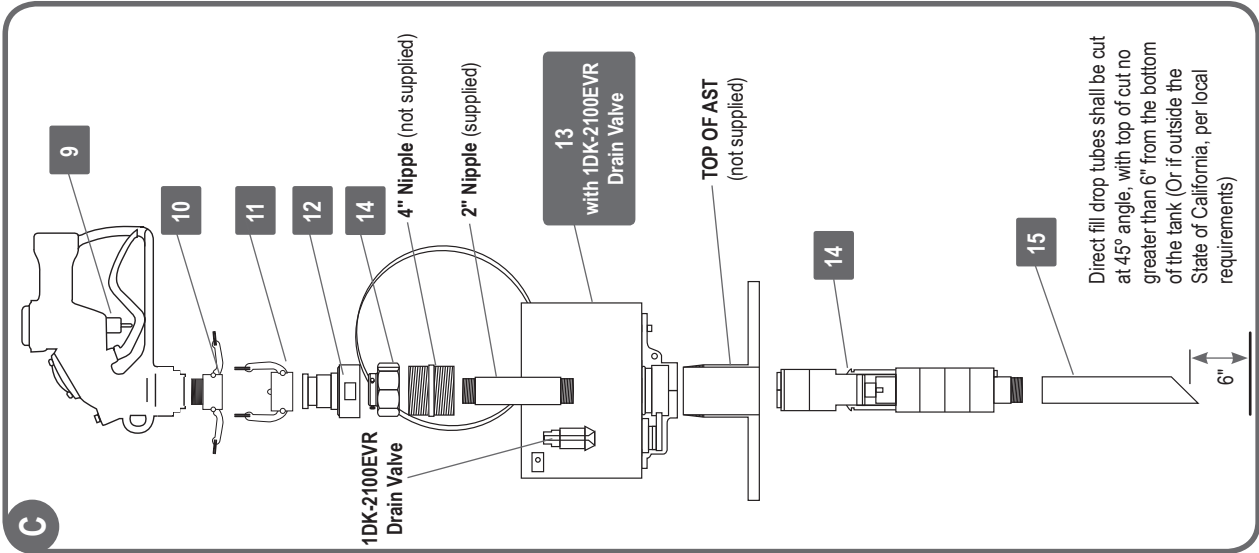
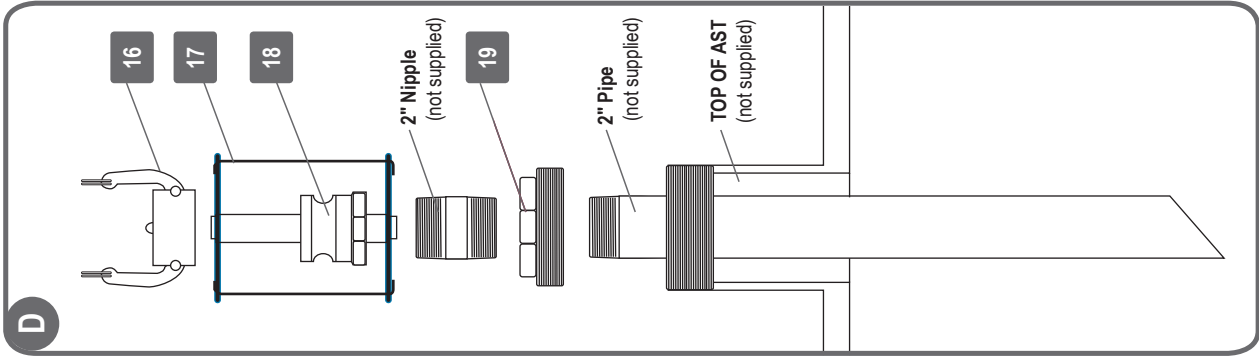

Above Ground Storage Tank - Remote Fill - Remote Dispensing Typical Non-EVR Remote Fill / Remote Dispensing AST Application

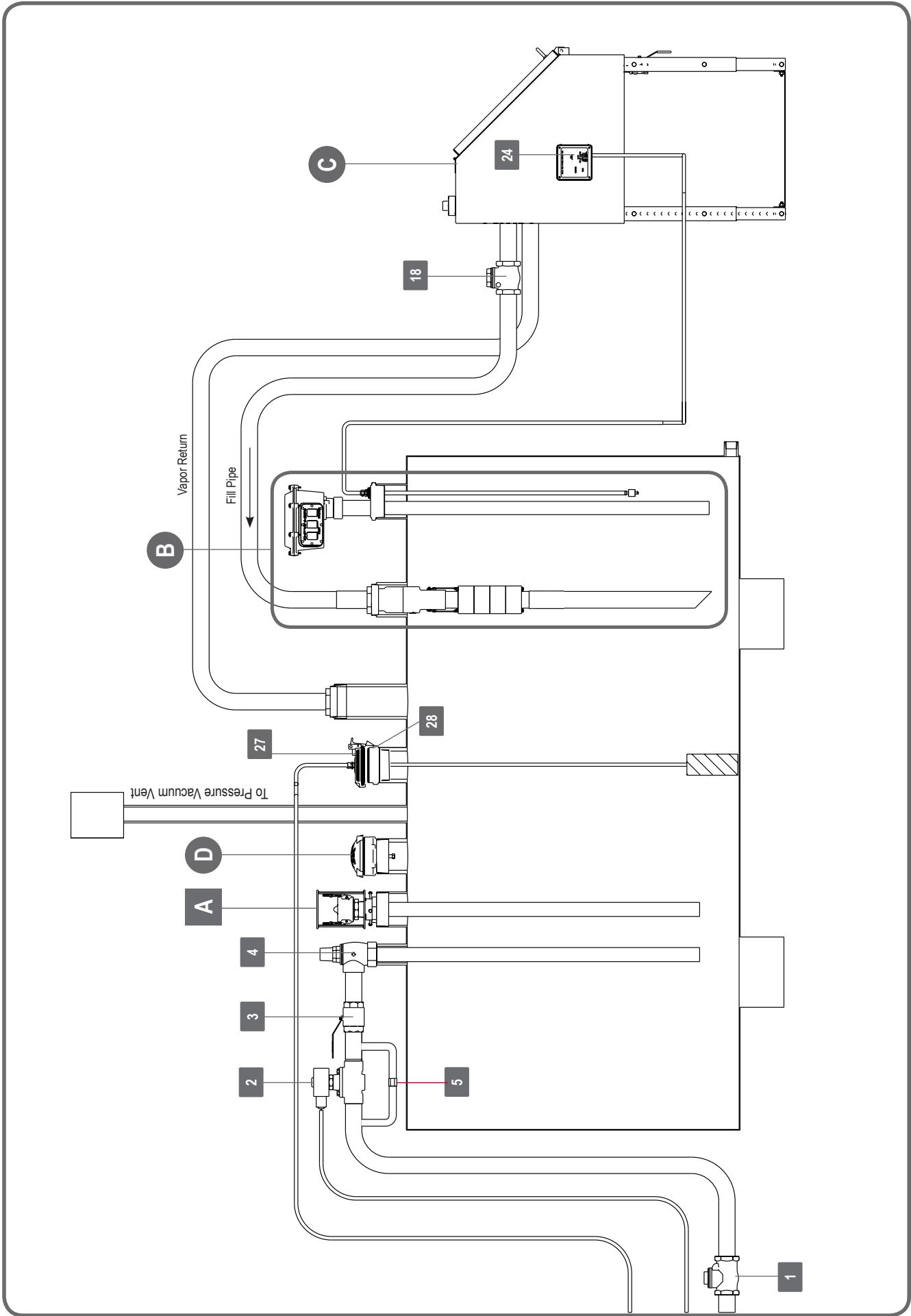

PRODUCT KEY

KEY	OPW PART / DESCRIPTION	PAGE
1	178S Series Emergency Valve	263
2	821 Series Solenoid Valve	261
3	21BV Series Ball Valve	262
4	199ASV Series Anti-Siphon Valve	260
5	82RV Series Pressure Relief Valve	261
6	53-00XX Series Double Tapped Bushing	127
7	634B-0150 or 634BK-0090 Cap	250-251
8	204247 Fill Prevention Cage	250
9	633AST-2190 Adaptor	250
10	301 Series Emergency Vent - Threaded Mount (See Vent Size Configuration Guide on page 244)	254
11	301 Series Emergency Vent - Flanged Mount (See Vent Size Configuration Guide on page 244)	254
12	61HSTOP-XXXX Series Overfill Prevention Valve	248,249
13	61FT Series Drop Tube	249
14	200TG-ENG Series Tank Gauge (optional / see Note below)	252
15	61T Series Drop Tube	128
16	TGTA-0400 4" Gauge/Alarm Combo Fitting (optional)	253
17	44TA-LFS Liquid Level Float Switch	253
18	175 Series Swing Check Valve	264
19	6211R Series Remote Spill Container	247
20	1611AN-0200 or 1612AN-0200 - 2" Remote Fill or 1611AN-0300 or 1612AN-0300 - 3" Remote Fill Kamvalok Adaptor	251
21	A) 634B-0140 Dust Cap fits 633AST-0150 Adaptor B) 634B-0150 Dust Cap fits 633AST-2061 or 633AST-0200 Adaptor C) 634B-0160 Dust Cap fits 1611AN-0200 or 633ST-0250 or 1611AN-2040 or 1612AN-2040 Adaptors D) 634B-0170 Dust Cap fits 1611AN-3060 or 1612AN-3060 Adaptors	250
22	1711D / 1712D Series Kamvalok Coupler	251
23	1711T-7085-EVR Cap or 1711LPC-0300 Low Profile Cap (optional / see Note below)	113
24	144TA/444TA Series Tank Alarm (optional / see Note below)	253
25	1611AV Vapor Recovery Adaptor	112
26	61VSA Series Vapor Recovery Adaptor	111
27	62M Series Monitoring Probe Cap & Adaptor	114
28	FSA-400 Face Seal Adaptor	59

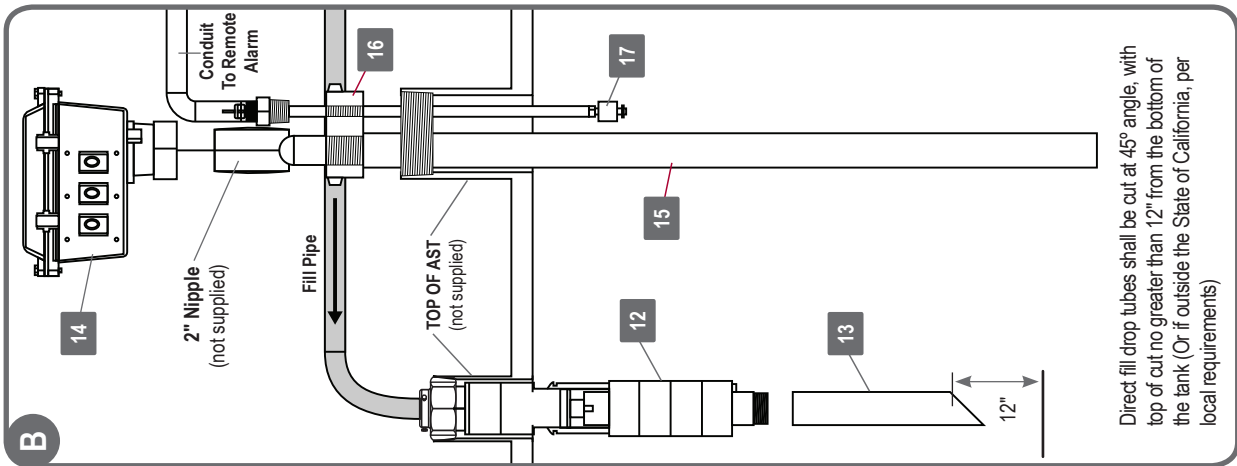
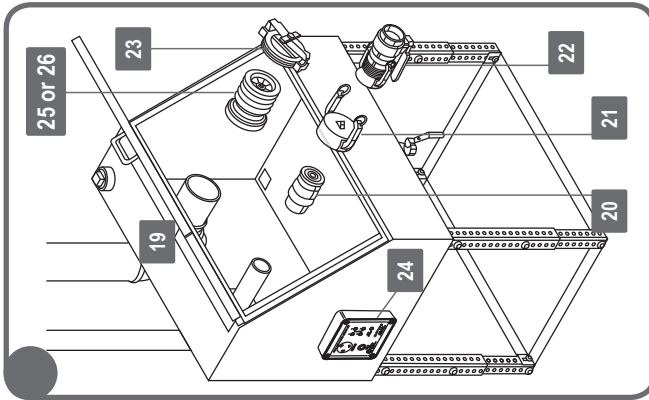

Direct fill drop tubes shall be cut at 45° angle, with top of cut no greater than 12" from the bottom of the tank (Or if outside the State of California, per local requirements)

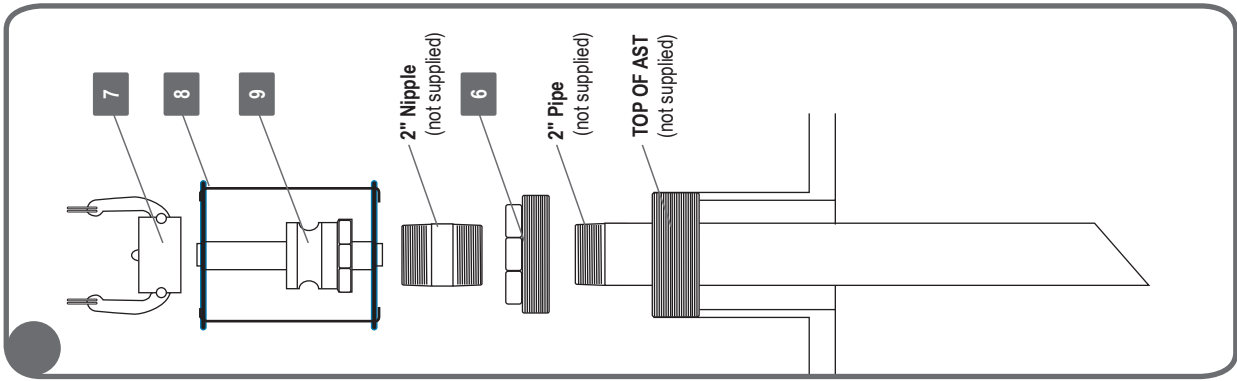

NOTE: The OPW 200TG and 144TA/444TA are not required for EVR compliance, but if a tank gauge or tank alarm is used on your tank that these two OPW products are the only CARBAST EVR certified tank gauge and alarm.

OPW AUTOMATIC NOZZLE FEATURES – MULTIPLE SOLUTIONS FOR MULTIPLE CUSTOMERS

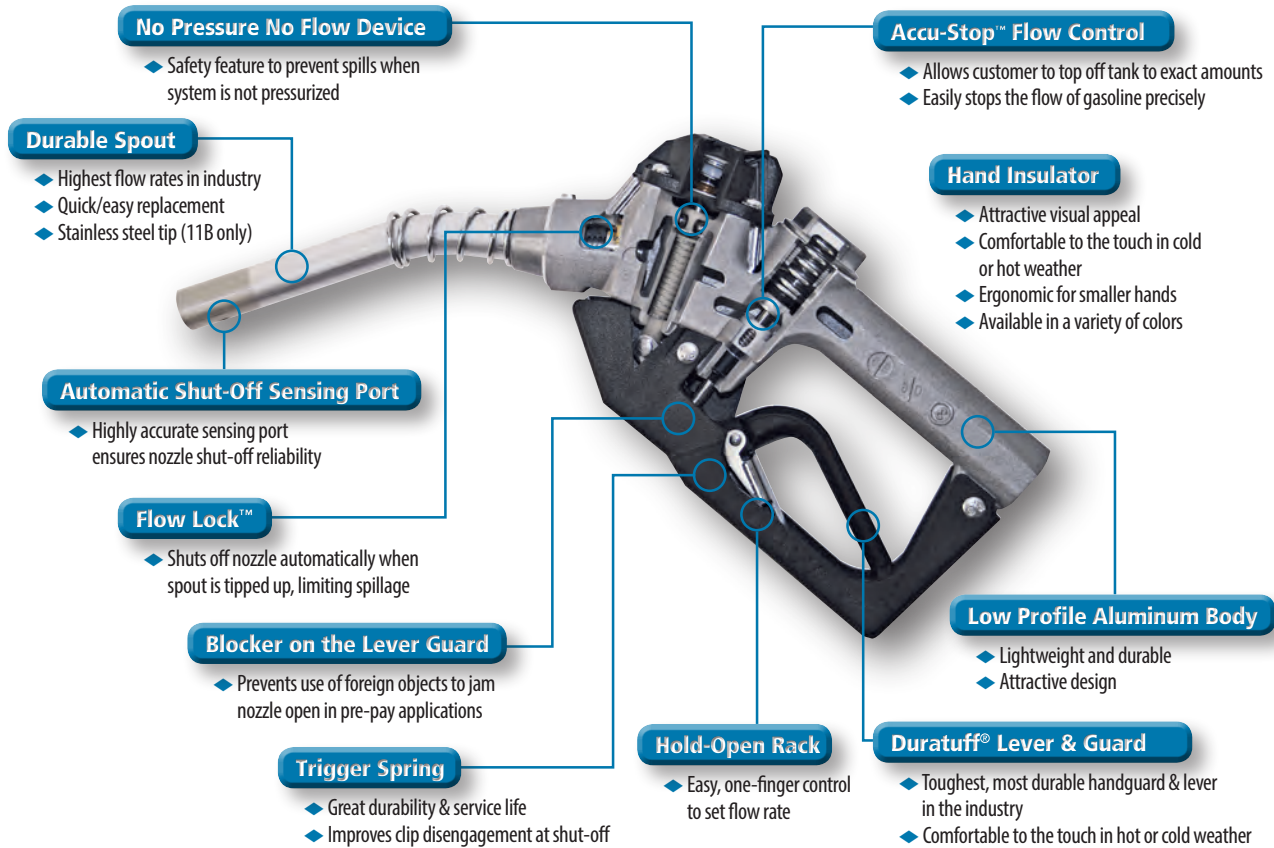

OPW MULTI-TIER PRODUCT PORTFOLIO

VALUE

PREMIUM

AUTOMATIC NOZZLES

		11A™ - w/o No Pressure No Flow
		11B™ - w/ No Pressure No Flow
		21Ge™ - E85-Compatible w/ No Pressure No Flow
AstroVac™ - Vacuum Assist	Astro™ - w/o No Pressure No Flow	21Gv™ - ORVR Vacuum Assist
	AstroB™ - w/ No Pressure No Flow	11VF™ - Balance
	12VW™ - Vacuum Assist	7HB™ - 1" Diesel, High Flow
		11B™ - 3/4", Auto Diesel

BREAKAWAYS

66V™ - Single Use	66REC™ - Reconnectable	66SB™ - Swivel Breakaway
66ISU™ - Vacuum Assist, Single Use	66CAS™ - Vacuum Assist Reconnectable	66ISB™ - Vacuum Assist Swivel Breakaway
66CSU™ - Balance, Single Use	66CL™ - Balance Reconnectable	66CLP™ - Balance Reconnect w/ Vapor Poppet

SWIVELS

241TPS™ - Two Plane	20S™ - Two Plane, High Flow	45™ - Two Plane, High Flow, Full Rotation
---------------------	-----------------------------	---

Bulk/Manual Nozzle Descriptions

Automatic Bulk Fueling

1290 - Automatic shut-off for heavy-duty high-flow truck, bus and home fuel oil delivery. Right angle design, dual poppets and 2-position hold-open device. Available with 1 1/2" inlet (NSN 4930-01-290-0756)

1290G - 1 1/2" inlet designed to meet military specifications. Available in green anodized (1290G-0050; NSN 4930-01-352-1660) or tan anodized (1290GS-0050; NSN 4930-01-352-1661) with ground wire assembly and kamlok coupler with dust plug; 1290GS-AR50 tan anodized without kamlok coupler and dust plug also available.



1290

Overwing Aircraft Fueling

295AF - Special heavy-duty fueling nozzle with knurled spout and spout protector ring. Gov't Nat'l. Stock # 4930-01-293-4472. With Air Force ground wire, plug meets MS 25384-5.

295SA - AVGAS fueling nozzle with 1", 1 1/4" & 1 1/2" threaded inlets available. **RED** composite lever guard denotes AVGAS. Complete with built-in swivel, ground wire assembly & dust cap.

295SAC - AVGAS fueling nozzle with 1 1/4" & 1 1/2" threaded inlets available. Complete with built-in swivel, ground wire assembly, dust cap and check valve.

295SAJ - JET FUEL fueling nozzle with unique spout design to prevent cross-fueling. **BLACK** lever guard denotes JET FUEL. Available in 1 1/2" threaded inlet with built-in swivel, dust cap and ground wire included.

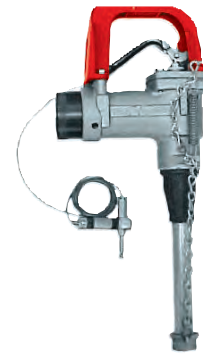

295SA

High-Flow Bulk Fueling

190 - Right angle design, dual poppets, replaceable hold-open rack. Available in 1", 1 1/4", 1 1/2" & 2" threaded inlets.

210 - Right angle design, dual poppets, replaceable hold-open rack, dash pot to minimize line shock. Available in 1 1/4" & 1 1/2" threaded inlets.

295SC - Right angle design, dual poppets, replaceable hold-open rack, adjustable dash pot to minimize line shock; built-in swivel and check valve. Available in 1 1/4" & 1 1/2" threaded inlets.



210

General Duty

RF400 - The OPW RF400 nozzle is designed for use in non-retail, commercial, industrial and agricultural use where an automatic nozzle is not needed.



RF400

NOTE: See OPW's Website at www.opwglobal.com for product instruction sheets, trouble shooting guides, how-to-use guide and to view the Do's & Don'ts at the Gas Pump video.

UL2080/UL2085

- Fireguard® was the first AST of its design to obtain a UL Listing for secondary containment.
- Fireguard®'s secondary containment can be tightness tested on-site with standard testing procedures.
- Fireguard®'s exterior steel wall provides superior weatherability and low-cost maintenance. Unlike concrete, cracking or spalling will never be a problem.
- Fireguard®'s unique thermal insulating material is 75% lighter than concrete....shipping, installation and relocation costs (and headaches) are reduced!
- Unlike some competitive tanks, UL Listed 110% secondary containment is standard with every Fireguard®
- An average 12,000 Fireguard® weights under 40,000 pounds - well within the legal load limit for trucking.
- 30-year warranty is standard with every Fireguard®



Areo UL142

- Cost Effective
- Complete Unit is UL142 Listed
- Visual Leak Detection
- Leasing or Financing Available
- Integral Overfill Protection
- Areo-Powers Unique Rainshield System Allows no Discharge of Product into Environment
- System is Relocatable as Needs Change
- Tanks can be used for Diesel, Gasoline, Jet Fuels, Heating Oils, Fertilizers, Hazardous Wastes or Chemicals
- Interior Linings Available on Request



Diesel Package Systems

- 18 GPM Pump w/Meter and 3/4" x 12' UL Listed Fuel Hose (115V)
- Automatic Nozzle
- 3/4" Filter Adapter
- 1" Suction Tube
- 2" Float Level Gauge
- Safebeak w/ Straightening Hose
- 2" Aluminum Normal Vent Cap
- 2" Sch 40 Pipe x 8'
- 2" Vent Whistle
- 4" Lettering "DIESEL ... GALLONS" (x 2)



Tank Capacity (gal)	Safety Containment (gal)	Containment Dimensions	Shipping Weight (lbs)
300	330	7' x 4' x 1'8"	1,600
500	550	7'5" x 6' x 1'8"	2,100
1,000	1,100	12' x 6' x 2'	3,900
1,500	1,650	13'10" x 8' x 2'0"	4,950
2,000	2,200	16' x 8' x 2'4"	6,000
3,000	3,300	22' x 8' x 2'9"	7,500
4,000	4,400	27' x 8' x 2'9"	9,000
4,000	4,400	12'5" x 10'10" x 5'	9,500
5,000	5,500	17' x 10'10" x 4'	11,500
6,000	6,600	20'6" x 10'10" x 4'	13,000
8,000	8,800	27'6" x 10'10" x 4'	17,000
10,000	11,000	35' x 10'10" x 4'	21,000
12,000	13,200	36'9" x 12' x 4'	23,000
15,000	16,500	31' x 12' x 6'	30,000
20,000	22,000	41' x 12' x 6'	34,000
30,000	33,000	62'2" x 12' x 6'0"	41,000

Act-100

- ACT-100® Steel/FRP composite tank features a strong steel tank for structural integrity, and a 100-mil fiberglass outer coating for long-lasting corrosion protection. Double-wall design allows continuous interstitial leak detection and monitoring.
 - Meets UL 58, UL 1746 and ULC-S603.1
 - A high-voltage holiday test of the coating assures that the steel is isolated from corrosive soils
 - Can be used with a variety of leak detection systems
 - Steel provides complete compatibility with all blends of ethanol and biodiesel fuels
 - Impermeable to all petroleum products and vapors
 - No failures due to external corrosion in its history
 - Flat end design reduces the cost of installation and increases site layout flexibility
-



Permatank®

- PERMATANK® double-wall jacketed underground storage tank features an inner steel tank coupled with an exterior corrosion-resistant fiberglass tank. A unique standoff material separating the inner and outer tanks creates a uniform interstitial space ensuring rapid and accurate leak detection.
- Meets UL 58, UL 1746 and ULC-S603.1
- All tanks proven tight throughout installation, via third party certification, by interstitial vacuum test -13 inches Hg minimum
- Provides many options to meet EPA leak detection requirements for interstitial monitoring, including the Permatank Precision Vacuum Monitor
- Steel provides complete compatibility with all blends of ethanol and biodiesel fuels
- Impermeable to all petroleum products and vapors



Encore S Series

- Refined bezel and columns enhance the appearance
- Brand View canopy and eye-level graphic reinforces retailers brand image
- Customer-defined, centralized layout
- Intuitive customer interface
- Large buttons with positive feedback
- SMART Merchandising™ drives in-store sales
- SMART Connect™ increases site uptime
- SMART Flow™ increases throughput to drive profits
- Security features to prevent unauthorized access
- Physical entry control with site-specific locks
- Hidden security clasp accepts an optional padlock
- Requires POS authorization to activate manager's keypad
- Programmable codes for site level security
- If pulse not detected, dispenser goes into slow flow/no flow
- Payment/Data Security
- Encrypting card reader and PIN Pad options to prevent card/PIN skimming
- Increased payment privacy
- Logging of price changes allows monitoring for unscheduled programming
- Forward and backward compatible Encore electronics
- Flexible to upgrade and grow with your business



Encore 500 S

- Styled bezel speeds selection, payment and throughput
- Intuitive interface speeds transactions
- Progressive lighting cues for easy product selection
- Positive feedback for easier grade selection
- Payment options: contactless card reader, cash, major oil cards, credit, debit, RFID, bar code
- High speed USB printer for coupons
- Dynamic monochrome display
- Optional color display
- Four-year corrosion coverage on all visible surfaces
- Two-year warranty includes travel, parts and labor
- Scratch and chemical resistant display lenses
- Longest lasting, super bright LEDs
- Angled hose outlets reduce scuffs
- Runs on 5" Monochrome or 10" color
- You control the content and coupons
- Increases inside sales as much as 10%
- POS Independent
- Coupon redemption rates up to 60%
- Easily track promotions, specials and coupons
- Remote diagnostics and focused troubleshooting lowers service costs
- Lowers compliance costs by tracking tank gauge and dispenser data
- Enables faster throughput with real time flow rates and low-flow alarms
- Greater site control with detailed alarms, such as price changes
- Delivers fast, consistent flow, even when sites are at their busiest
- Provides benefits of variable-speed STPs without the higher cost
- Reduces costs by eliminating the need for mechanical flow limiters

Legacy Series Electronic Pump



Model	Flow Rate	Products	Hoses	Pump/Dispenser	Standard Motor	Shipping Weight (kg)	Shipping Volume (m3)
JH1000	Standard	1	1	Pump	3/4 HP	169	1.1
JH1100	Standard	1	2	Pump	3/4 HP	190	1.1
JH1200	Standard	2	2	Pump	3/4 HP	219	1.1
JH1300	High	1	1	Pump	3/4 HP	160	1.1
JH1500	High	2	2	Pump	3/4 HP	250	1.1
JHA000	Standard	1	1	Dispenser	N/A	95	1.1
JHA100	Standard	1	2	Dispenser	N/A	115	1.1
JHA200	Standard	2	2	Dispenser	N/A	170	1.1
JHA300	High	1	1	Dispenser	N/A	115	1.1
JHA400	High	1	2	Dispenser	N/A	130	1.1
JHA500	High	2	2	Dispenser	N/A	140	1.1

Legacy Series Titan Mechanical



Model	Type	Sides	Products	Hoses	Pump	Motors	Flow Rating
KMA300	Dispenser	2	1	1	n/a	n/a	HF
KMA400	Dispenser	2	1	2	n/a	n/a	HF
KMA500	Dispenser	2	2	2	n/a	n/a	HF
KM1300	Pump	2	1	1	1	(1) 1 HP	HF
KM1100	Pump	2	1	2	1	(1) 1 HP	SF
KM1400	Pump	2	1	2	2	(2) 1 HP	HF
KM1500	Pump	2	2	2	2	(2) 1 HP	HF

Legacy Series Commercial Pump

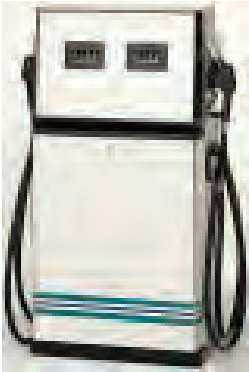

Model	Flow Rate	Products	Hoses	Pump/Dispenser	Standard Motor	Shipping Weight (kg)	Shipping Volume (m3)
JC1000	Standard	1	1	Pump	3/4 HP	140	0.8
JC1100	Standard	1	2	Pump	3/4 HP	220	0.8
JC1200	Standard	2	2	Pump	3/4 HP	250	0.8
JC1300	High	1	1	Pump	3/4 HP	154	0.8
JC1500	High	2	2	Pump	3/4 HP	270	0.8
JCA000	Standard	1	1	Dispenser	N/A	110	0.8
JCA100	Standard	1	2	Dispenser	N/A	140	0.8
JCA200	Standard	2	2	Dispenser	N/A	140	0.8
JCA300	High	1	1	Dispenser	N/A	120	0.8
JCA400	High	1	2	Dispenser	N/A	145	0.8
JCA500	High	2	2	Dispenser	N/A	140	0.8

Ultra-Hi Master



Model	Flow Rate	Products	Hoses	Pump/Dispenser	Standard Motor	Shipping Weight (kg)	Shipping Volume (m3)
JHB310	High	1	1	Master Dispenser	N/A	115	1.1
JHB410	High	1	2	Master Dispenser	N/A	135	1.1
JHB510	High	2	2	Master Dispenser	N/A	165	1.1
JHB600	Ultra-Hi	1	1	Master Dispenser	N/A	125	1.1
JHB800	Ultra-Hi	2	2	Master Dispenser	N/A	140	1.1
JHC310	High	1	1	Satellite Dispenser	N/A	90	1.1
JHC510	High	2	2	Satellite Dispenser	N/A	90	1.1
JHC600	Ultra-Hi	1	1	Satellite Dispenser	N/A	90	1.1
JHC800	Ultra-Hi	2	2	Satellite Dispenser	N/A	90	1.1
JHD510	High	2	2	Master/Satellite Combo	N/A	135	1.1
JHD800	Ultra-Hi	2	2	Master/Satellite Combo	N/A	135	1.1

Atlas Fleet Mechanical Pumps and Dispensers

- Brightly lit brand area and display
- Improved flow-through meter increases reliability
- Vane type pumping unit does not require special priming procedure
- Heavy duty 13-gauge, galvanized frame and lower panels
- Fully removable door for easier access and service with plenty of room to work
- Removable side and top sheathing black or customer specified color, or stainless steel side and top panels
- Customizable graphic options on lower door



Super High Flow (up to 40gpm/151 lpm)

Model	Type	Hoses	Products	Motors	Meters
9140K	Pump	Single	1	(2) 1hp c.d.	(2) Gilbarco CFT
JH1100	Standard	1	2	Pump	3/4 HP

High Flow (up to 22 gpm/83 lpm)

Model	Type	Hoses	Products	Motors	Meters
9153K	Pump	Single	1	(1) 1hp c.d.	Gilbarco CFT
9152KTW1	Pump	Twin	1	(1) 1hp c.d.	Gilbarco CFT
9153KTW1M	Pump	Twin	1	(2) 1hp c.d.	Gilbarco CFT
9153KTW2	Pump	Twin	2	(2) 1hp c.d.	Gilbarco CFT
9153KX	Dispenser	Single	1	n/a	Gilbarco CFT
9153KXTW1	Dispenser	Twin	1	n/a	Gilbarco CFT
9153KXTW2	Dispenser	Twin	2	n/a	Gilbarco CFT

Atlas Fleet Electronic Pumps and Dispensers

Ultra High Flow (up to 50 gpm/189 lpm)

Model	Type	Hoses	Products	Motors	Meters
9850K	Pump	Single	1	(1) 1-1/2 hp c.d.	Liquid Controls
9850KTW3	Pump	Combo	1	(1) 1-1/2 hp c.d.	Liquid Controls
9850KX	Dispenser	Single	1	n/a	Liquid Controls
9850KXTW1	Dispenser	Twin	1	n/a	Liquid Controls
9850KXTW2	Dispenser	Twin	2	n/a	Liquid Controls



Super High Flow (up to 40gpm/151 lpm)

Model	Type	Hoses	Products	Motors	Meters
9840K	Pump	Single	1	(2) 1hp c.d.	(2) Gilbarco CFT
9840KX	Standard	Single	1	n/a	(2) Gilbarco CFT

High Flow (up to 22 gpm/83 lpm)

Model	Type	Hoses	Products	Motors	Meters
9853K	Pump	Single	1	(1) 1hp c.d.	Gilbarco CFT
9852KTW1	Pump	Twin	1	(1) 1hp c.d.	Gilbarco CFT
9853KTW1M	Pump	Twin	1	(2) 1hp c.d.	Gilbarco CFT
9853KTW2	Pump	Twin	2	(2) 1hp c.d.	Gilbarco CFT
9853KX	Dispenser	Single	1	n/a	Gilbarco CFT
9853KXTW1	Dispenser	Twin	1	n/a	Gilbarco CFT

Atlas Fleet Satellite Dispensers

Model	Works With	Hoses	Products	GPM(LPM)	Motors	Meters
215Q	9153KX 9853KX	Single	1	Up to 21	n/a	n/a
215Q-Z		Single	1	Up to 21	n/a	n/a
215QTW-Z		Twin	1	Up to 21	n/a	n/a
216Q	9850KX 9840KX 9140KX	Single	1	Up to 40	n/a	n/a
216Q-Z		Single	1	Up to 40	n/a	n/a
216QTW-Z		Twin	1	Up to 40	n/a	n/a



Atlas Retail Mechanical Pumps and Dispensers

Model	Type	Hoses	Products	Motors	Meters
8753K	Pump	Single	1	(1) 1hp c.d.	Gilbarco CFT
8752KTW1	Pump	Twin	1	(1) 1hp c.d.	Gilbarco CFT
8753KTW1M	Pump	Single	1	(2) 1hp c.d.	Gilbarco CFT
8753KTW2	Pump	Twin	2	(2) 1hp c.d.	Gilbarco CFT
8753KX	Dispenser	Single	1	n/a	Gilbarco CFT
8753KXTW1	Dispenser	Twin	1	n/a	Gilbarco CFT
8753KXTW2	Dispenser	Twin	2	n/a	Gilbarco CFT

Atlas Retail Electrical Pumps and Dispensers

Model	Type	Hoses	Products	Motors	Meters
8853K	Pump	Single	1	(1) 1hp c.d.	Gilbarco CFT
8852KTW1	Pump	Twin	1	(1) 1hp c.d.	Gilbarco CFT
8853KTW1M	Pump	Twin	1	(2) 1hp c.d.	Gilbarco CFT
8853KTW2	Pump	Twin	2	(2) 1hp c.d.	Gilbarco CFT
8853KX	Dispenser	Single	1	n/a	Gilbarco CFT
8853KXTW1	Dispenser	Twin	1	n/a	Gilbarco CFT
8853KXTW2	Dispenser	Twin	2	n/a	Gilbarco CFT

ACCU-FUELER

The Accufueler Unitized Dispensing System is an efficient, practical economical, compact and self contained unit for filtering, metering and dispensing of products such as gasoline, jet fuels, fuel oil, diesel fuel and other liquids. The unit registers in volume and computes, at any given price, the money quantity. Register options include a mechanical stand alone computer or an electromechanical unit capable of exchanging information with an external control console. Metering, computing, filtering and dispensing elements are carefully selected to meet exacting specifications which will achieve the desired performance and are then engineered into a unitized system. The system is then enclosed in a specially designed corrosion resistant stainless steel cabinet that allows for easy access and lockable security. Accu-Fueler Unitized Dispensing systems are available in three turnkey packages, a high capacity mechanical, a high capacity-electromechanical and an electro-mechanical ultra high capacity unit.

Model FSM-201 is the standard mechanical unit for use in full-time attended operations, model SSE-201 is the electro-mechanical unit for use in self serve or console controlled operations and model SSE-501 is the top of the line, high capacity, electro-mechanical model for use in high traffic, self serve or console controlled applications.

SSE-201 FEATURES

- High capacity electro-mechanical fuel dispensing system.
- Fully enclosed, vandal-proof turnkey system.
- Electronic volume & price computer with remote price setting/ remote authorization and self service capabilities.
- Stainless steel, corrosion resistant, lockable outer skin.
- Slo-down valves.
- All aluminum internal piping for corrosion resistance.
- 25 GPM Built-in filter/separator.
- Positive displacement high accuracy 25 GPM meter unit.
- *Electric rewind hose reel.
- 50 ft. 1" hose.
- High-flo Automatic fuel nozzle, 1" O.
- All components are U.L. Approved.

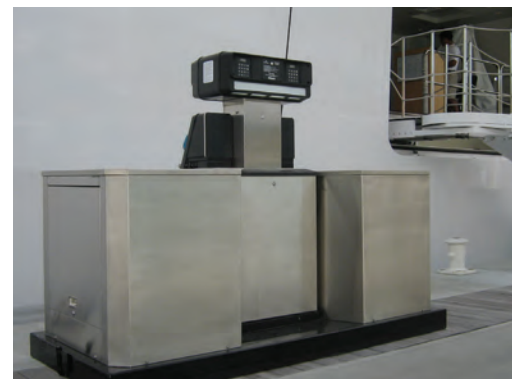

CEM-44 Software

- Solves routinely tasks with automatic processes (prices, shift closings, etc.)
- Fraud Control
- Sales inventory, deliveries, inventory, stock and reports key about your business
- Manage full and self-service with pay at the pump
- Direct interface with ATG

	CEM ⁴⁴	CEM ^{XS}
Fueling Positions up to	32	16
ATG Veeder-Root Interface	✓	—
Delivery Authorization	✓	✓
Integration with third-Party Back-Office system	✓	—
Shift Closure	✓	✓
Graphics displays	✓	—
Inventory Administration	✓	✓
Security Mode	✓	—
Integration with third-Party Pos system	✓	✓
Remote Console	✓	—
Grouping dispensers	✓	—

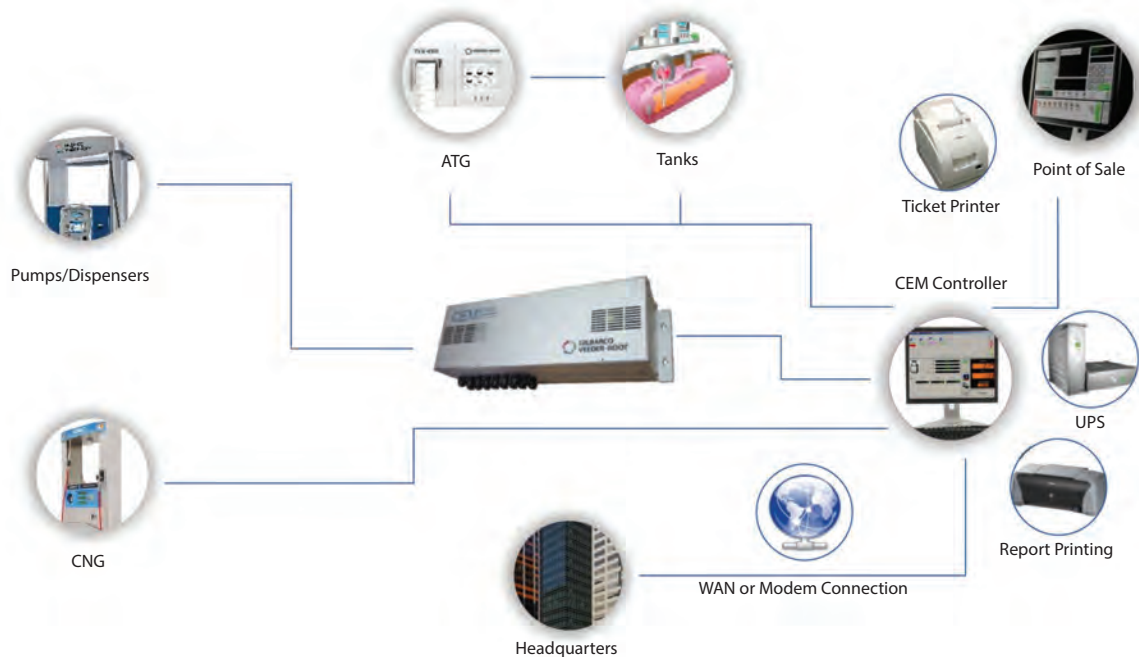

Ruby SuperSystem

Better Control, Better Customer Service

- Single control point for fuel sales supporting both preset and prepay fuel sales
- Electronically tracks up to 32 fueling positions on an icon display screen
- Cashiers can easily view the payment status of all pumps and quickly authorize fuel sales using a single key entry

Complete Connectivity

The Ruby SuperSystem works with more industry leading partners than any other industry POS. These partner relationships offer you the freedom to choose from:

- All major oil networks
- Major petroleum generic networks for multi-branded jobbers
- All major dispensers and dispenser card readers (Bennett DCA, Gilbarco CRINDS, Tokheim DPT, Schlumberger CSC, and Wayne DCPT)
- Back office partners for inventory and c-store management
- Scanners for increased PLU control
- Car wash controllers (requires Ruby Card)
- Tank level monitors
- Fast Food "Pre-Checking" (requires Ruby Card Bravo)
- Remote Fuel Price Signs (requires Ruby Card and Sapphire)
- Money order machines (requires Ruby Card Bravo)

Network and Payment Flexibility

- Interfaces with a wide range of petroleum card networks, including those that communicate with independent oil companies
- Standardization of operations for a variety of stations including major and independent gasoline brands
- For both pay-at-the-pump and instore sales, supports and speeds transactions for major oil-branded network cards and fleet fuel cards, as well as major credit and debit cards

Loyalty Options

- Built-in loyalty options include POP Fuel, Mix and Match, and Combo
- Helps increase customer retention and in-store sales opportunities
- Third party loyalty programs can also be implemented using Sapphire



Canopy Lighting - Legacy



Purpose Built - Flat Lens

- Designed to Replace the LSI Scottsdale – installs quickly into existing 4" hole without extra cutting, drilling or caulking
- Available in 2 sizes and lumens up to 23,523
- CRU- 20 3/4" x 20 3/4" with range of 19,630 – 23,523 lumens
- CRUS- 15 15/16" x 15 15/16" with range of 10,871 - 13,554 lumens
- One-person Installation - Fastest, easiest installation in the marketplace
- High Performance, Low Cost – most cost-effective LED canopy fixture in the marketplace

Performance Driven

- Highest Lumen Per Dollar – tremendous flexibility in how you light your site
- Choice of Lumen Packages – up to over 23,000 lumens
- Better Light Distribution – more illumination on your dispensers
- Designed for utility and/or DLC approval and rebate participation

Stunningly Attractive – day and night!

- Extremely Slim Optical Unit –flush look against the canopy
- During the day the CRU disappears, assuring that attention goes to your marketing elements, not the canopy fixture
- Full panel brilliance, properly scaled to your canopy, with no annoying gaps or glaring diode point sources

Canopy Lighting - Scottsdale Legacy



Purpose Built - Dropped Glass

- Designed to Replace the LSI Scottsdale – installs quickly into existing 4" hole without extra cutting, drilling or caulking
- CRUS SCDL is available in 1 size of 15 15/16" x 15 15/16" with a range of 9,379 – 13,084 lumens
- One-person Installation -- fastest, easiest installation in the marketplace
- High Performance, Low Cost – most cost-effective LED canopy fixture in the marketplace
- Single or Double Deck Canopies with Dry Plenums

Performance Driven

- Highest Lumen Per Dollar – tremendous flexibility in how you light your site
- Choice of Lumen Packages – up to over 13,000 lumens
- Better Light Distribution – more illumination on your dispensers
- Designed for utility and/or DLC approval and rebate participation

Stunningly Attractive – day and night!

- Prismatic glass lens – bright, white light with diamond-like precision
- Excellent long-range visibility – day and night

The Red Jacket Submersible Turbine Pump

Performance Benefits

- Available fixed and variable speed
- Lowest pressure drop across the packer manifold optimizes flow with any sized motor

Environmental Benefits

- Service spill elimination
- Check valve design
- Spill-free extractable
- Prevents false alarms and downtime
- Vacuum Sensor Siphon System
- Environmental compliance without fuel flow restrictions
- Integrates with V-R PLLD systems
- Wide range of fuel compatibility
- Diesel; 100% gasoline; 80% gasoline with 20% TAME, ETBE, or MTBE
- 0-100% Ethanol; 0-100% Methanol
- Service and installation benefits
- Quick, simple and safe yoke assembly
- Easy to service and install extractable
- Manifold design flexibility for vertical or horizontal discharge
- Built-in contractor's box eliminates need for yoke adjustments



Maxxum Big Flo

Performance

- Highest flow rate of any 6" fixed speed STP
- Redesigned flow path reduces flow restrictions

Environmental

- Compatible with Veeder-Root PLLD
- Vapor recovery pump driving port
- Transducer port for electronic leak detection

Service and installation benefits

- Easy and safe electrical yoke disconnect
- Easy termination of pump wiring in conduit box
- Quick removal of extracta pump head
- Quick accessibility of check valve



IQ Control Box

Performance

- Provides motor protection from dry run conditions
- Protects wiring and controls from locked rotor or high currents
- Monitors site power conditions to ensure uninterrupted fueling and long motor life

Service and installation benefits

- Single press and hold button for easy calibration
- Easy-to-use wiring terminal with familiar labeling
- Easily retrofitted to existing locations



Isotrol 1-8

Performance

- Isolates the handle signals between each dispenser
- Isolates and protects individual dispensers from wiring shorts or phasing issues
- Isolates and protects technicians from dangerous feedback during service

Service and installation benefits

- Dedicated Automatic Tank Gauge (ATG) line leak output and coil terminals are labeled for easy wiring and compatibility
- May be used with Red Jacket's Submersible Turbine Pump, Big Flo Pump or IQ Control Box, or as a "stand alone" with on-board 30-amp power relay
- Easily retrofitted to existing locations



PLLD Pressurized Line Leak Detection System

Performance

- Increased flow rate saves you money
- .5 GPM per nozzle higher flow rate vs. MLLD
- 2 GPM per nozzle higher flow rate vs. ELLD

Service and installation benefits

- Eliminates the recurring cost of replacement of MLLD
 - Eliminates the need for annual line testing
 - Eliminates the need for annual mechanical test
-

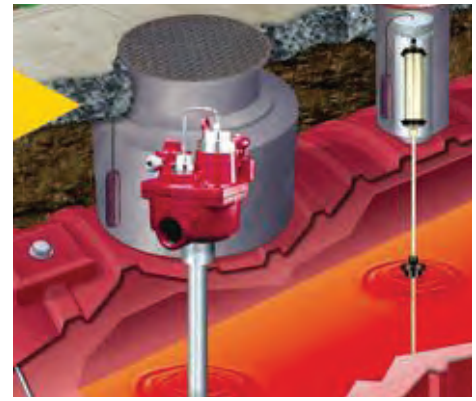

FXV System-Mechanical Leak Detection and Testing

Performance

- Guaranteed to detect at a rate of 3 gph at 10 psi for 24 months from date of manufacture
- Fast test times enable the FXV to operate effectively in areas that experience extreme temperature changes
- Handles a variety of fuels including diesel

Service and installation benefits

- Eliminates the recurring cost of replacement of MLLD
 - Eliminates the need for annual line testing
 - Eliminates the need for annual mechanical test
-



Trapper

Performance

- Specially designed screen blocks tank particulates from entering the fluid system, prolonging filter life
- Continuous slot design prevents accumulation and lodging of particles present in underground tanks, maintaining peak pumping performance

Service and installation benefits

- Reduces filter changes to as low as once per year per line, saving on labor and filter costs
- Reduces product spills and the potential for liability by reducing the number of filter changes
- Self-cleaning, non-clog design dramatically reduces maintenance costs



TLS-2P & TLS-2P

The TLS-2 and TLS-2P tank gauging systems can monitor up to 6 individual tanks, with a touch-screen display that's simple to understand and navigate. Ideal for station owners without sensor needs, the TLS-2 family provides easy- to-use, accurate fuel tracking and delivery information, and offers simple access to the most critical inventory data. Can also monitor density levels of gasoline or diesel fuel in your tanks.

- Report capabilities for inventory, deliveries, diagnostics shift and setup
- Tank leak test results
- Alarm and alarm history
- Capable of in-tank leak detection (0.1 and 0.2 GPH)
- Highly accurate inventory and water level readings
- Tank leak detection for up to 0.76 liter/hour (0.2 GPH) leaks when using Mag 2 Probes, 0.38 liter/hour (0.1 GPH) when using Mag 1 Probes
- Auto-dial on alarm when connected to an external modem



- Activation of remote alarm through relay
- Supports Veeder-Root, European BA and Hnn protocols
- Compatible with Veeder-Root Inform remote communication software

TLS-350 PLUS

The TLS-2 and TLS-2P tank gauging systems can monitor up to 6 individual tanks, with a touch-screen display that's simple to understand and navigate. Ideal for station owners without sensor needs, the TLS-2 family provides easy- to-use, accurate fuel tracking and delivery information, and offers simple access to the most critical inventory data. Can also monitor density levels of gasoline or diesel fuel in your tanks.

- 0.1 GPH and 0.2 GPH In-Tank Leak Detection with Magnetostrictive Probes
- Continuous Statistical Leak Detection (CSLD) continuous 24-hour leak detection - upgrade option
- Electronic line leak detection capabilities
- Vapor and groundwater monitoring
- In-station Diagnostics - upgrade option
- Secondary Containment Vacuum Sensing System (SCVS) - upgrade option
- Continuous inventory monitoring
- Business Inventory Reconciliation (BIR) Accuchart - upgrade option
- Fuel Manager - upgrade option



- Complete inventory reports before and after generator operation
- SiteFax auto-dial fax capability
- Programmable alarms
- Compatible Sensors
- Compatible Probes

The TLS-450

The TLS-450 is future-forward technology and our most fully featured tank gauge solution. Designed to monitor and help protect your tanks, it offers industry-leading accuracy and maximum flexibility for your station operations. Manage inventory, deliveries, and alarm information from any computer, smart device/phone, or iPad – anywhere. Its intuitive graphical user interface and Web-enabled technology can be fully tailored and provide one-touch access to all federal, state, and local agency reports. This is technology designed to grow with you.



- Fewer and faster service calls through remote diagnostics and customized alarms
 - Remote or local site management with Direct Access Software, flexible networking options, and email notifications
 - Cost-effective wet stock management through robust data collection rules, confirming your tanks and lines are tight, and providing convenient wet stock reports on-demand
 - Flexible and upgrade-ready from advanced processing power and architecture to highly flexible configuration and remote upgrades
 - Mistake-proof operation through its intuitive graphical user interface, onboard help function and custom alarm management
-

TOPKAT PLUS

Economical, easy-to-use TopKat Plus is a stand-alone Fuel Dispenser controller that can be mounted directly on the Gilbarco 9800 dispenser or pedestal. It can handle up to 50,000 devices and 25,000 transactions — and it works in unattended fueling, remote fueling, automated fueling and other applications.



From one TopKat Plus, you can control up to eight Gilbarco 9800 electronic hoses, or two mechanical hoses. For sites with multiple fueling islands, one TopKat Plus can provide common control and reporting for overall fleet and fuel management. In addition, TopKat Plus maintains all devices and transactional information in the embedded controller designed for the fleet fueling environment. Using optional Fleet Head Office software, you can communicate with an unlimited number of sites, automatically gather transactions and easily develop customized reports.

- Compact island controller - provides flexibility and scalability in system design
- Web-based interface - makes handling and analyzing fleet and fuel management system and usage data simple, so you get the information you need in the form you need it
- Economical cost - delivers productive performance in any size operation

Series 94 Coin-Operated Air Service

COIN-OPERATED & TOKEN AIR SERVICE CABINETS: Heavy steel construction powder coated for additional protection. Theft resistant locking assembly and larger capacity coin box. Available with dependable Duro reels or pedestal mounted.

OPERATION: Durable 3/4 H.P. oil-less compressor is wired to a time adjustable solid state timer and activated by an adjustable coin or factory token acceptor.



Model	Description	Weight
94-1P	Coin-operated air only, with compressor Pedestal mounted - no hose reel.	140
94-2P	Coin-operated air - free water with compressor Pedestal mounted - no hose reel.	145
94-1R	Coin-operated air only, with compressor One hose reel 25 feet.	195
94-2R	Coin-operated air - free water with compressor Two hose reels 25 feet.	220

Self-Service Air & Water



Modular

Series 30
Series 31
Series 35
Series 36
Series 40
Series 41



Hose Guardian

Series 50
Series 51



Slim Line

Series 60
Series 65
Series 70
Series 75



Air Genie

Series 93



Underground Hose Reels

Air and Water Machines

Established Features

- Power: Heavy duty industrial twin cylinder oilless compressor
- Equipped with a new solid state motor switch to insure reliability and long life
- Colors: Silver, Yellow, Red and Black

Options

- Adjustable 1 to 10 coins
- Stainless Steel Cabinet
- Reel assembly retractors
- Vault Stand
- Basic Stand
- Water Kit
- Cut resistant hose

New Standard Features

- High Security locking system
- Recessed door for extra strength, and additional weatherproofing
- Reinforced steel cabinet structure of 10 and 14 gauge steel
- More vandal-resistant coin acceptor system
- Variable time time adjustment
- Low voltage for user safety
- Larger coin box



Model	Compressor HP	Standard Voltage	CFM 100 PSIG	Maximum Pressure PSIG	Shipping Weight
K-14-750	3/4	115/230/60	2.5	100	115 lbs.
K-14-750-AW	3/4	115/230/60	2.5	100	115 lbs.
K14-9	Remote	115/230/60	Remote Compressor	Remote Compressor	65 lbs.



Pedestal Mounted

Series 95



Sentry Lighting System

Series 96
Series 97
Series 98



ET Tower Gravity

Series 300

Waste Containers & Windshield Service Centers

These durable waste containers include three accessories in one: towel storage areas (towels not included), removable wash water buckets and squeegees. They are blow-molded of high density polyethylene that won't rust, dent or chip. The special interior splash guards are designed to protect the towels from waste and the telescopic lids lift off for easy waste removal. Anchor kits are available to bolt down bottom section for a secure unit in strong wind.

30-Gallon Waste Container



CU-30
• 29" H x 20" W x 17.25" D
• 13 lbs.
• Black, Gray and Beige

35-Gallon Waste Container



CU-3
• 31" H x 25.5" W x 23.25" D
• 27 lbs.
• Black

45-Gallon Waste Container



CU-45
• 29" H x 20" W x 17.25" D
• 18 lbs.
• Colors: Black, Gray, Charcoal

50-Gallon Waste Container



HEX-50
• 42" H x 25" W x 22" D
• 18.5 lbs.
• Black



Waste Container Dome Lids
Fits CU-45, HEX-50, CU-3, CU-50-1, CU-50-2
15.5" H x 22" W x 25" D
25 lbs.
Colors: Beige, Gray and Black



Drive-Through Dome Lids
• Fits CU-45, HEX-50, CU-3, CU-50-1, CU-50-2
• 48.5" H x 25" W x 22" D
• 27.5 lbs.
• Black

38-Gallon Telescopic Waste Container and Windshield Service Center



- CU-1**
- 30" H x 18.5" W x 19.75" D
 - 26 lbs.
 - Colors: Black, Gray and Blue

38-Gallon Telescopic Waste Container



- CU-2**
- 30" H x 18.5" W x 18.5" D
 - 16 lbs.
 - Colors: Black, Beige, Gray

Dome Lid



- CU-DOMELID**
- Four large 5" x 12.25" openings
 - Colors: Black, Beige, Gray and Blue

Ashtray Lid



- CU-DOMELID-ASH**
- Four large 5" x 12.25" openings
 - Colors: Black, Beige, Gray and Blue



55-Gallon Waste Container Windshield Combo WW2-55-G

- Charcoal



SIDE POD SB-3

- Colors: Dark Pearl and Charcoal



Waste Container Aluminum Panels

- 19.5" H x 13.5" W
- Single-side

45-Gallon Round Waste Container



- 45RND**
- 17 lbs.
 - Black



One-Ply Windshield Towels 426

- 9.1" H x 10.25" W towel size
- Case of 10 packs (224 towels per pack)

Two-Ply Windshield Towels 428

- 9.3" H x 10.5" W towel size
- Case of 16 packs (140 towels per pack)



**Service Center Combo
WW2-40**

- 34" H x 34" W x 16" D
- Black
- 38 lbs.



**40-Gallon Waste Container
WW-40**

- 34" H x 22" W x 17" D
- Black
- 18 lbs.



**Windshield Service Center
SB-4**

- 32.25" H x 14.75" W x 7.5" D
- Black
- 15 lbs.



**Single Bucket Windshield
Service Center
SB-VUE**

- 36.5H x 14.75" W x 9.5" D
- 11 lbs.
- Black



**Plastic Squeegee
WC-815**

- 16" from head to end
- 8" head
- 17 oz



**Truck Squeegee
SPQ-2**

- 39" head to end (open),
25.5" head to end (close)
- 8" Head
- 12 oz.



**Squeegee
WC-908**

- 39" head to end (open),
25.5" head to end (close)
- 8" Head
- 12 oz.



**Extra-Long Squeegee
SPQ-3**

- Telescoping handle
extends from 28" to 39".
Sold in packs of 3.
- 50" head to end (open),
30" head to end (closed)
- 8" Head
- 12 oz.



**SUV Squeegee
WC-820**

- 8" head
- 16 oz.



**Deluxe Squeegee Bucket
WSB**

- 14.5" H x 11" W x 7" D
- Black
- 2.75 lb



**The Pill Glass Cleaner by Unger
GC-PL100**

Water Detection & Particulate Removing Filter

300HS

Application

- Water detection and particulate removal which reduces flow substantially to indicate water contamination
- Compatible with gasoline, diesel, and ultra-low sulfur diesel (ULSD)
- Designed for gasoline or diesel service station pumps, commercial fueling dispensers, most Dresser, and Tokheim Service Station dispensers

Design Features

- 25 gpm (94.6 lpm) maximum flow
- 50 psi (3.4 bar) maximum working pressure
- 10 micron and 30 micron Hydrosorb available
- Designed to detect free water, emulsified water, and filters particulates
- Pre-Lubed Gaskets standard

Benefits

- Monitors water content of storage tank
- Added protection to gasoline dispenser meter chambers
- Recognized by the Underwriters Laboratory (UL) for use with service station pumps and dispensers
- Ease of installation with Pre-Lubed Gaskets

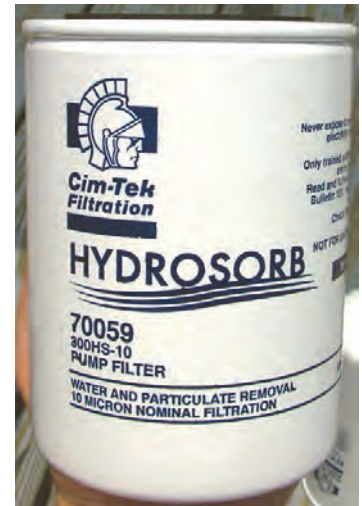

Ordering Information

Part No.	Model No.	Description
70059	300HS-10	Spin-On Filter for Water Detection and Particulate Removal with 10 Micron Hydrosorb® Media. (1"–12 UNF Thread)
70064	300HS-30	Spin-On Filter for Water Detection and Particulate Removal with 30 Micron Hydrosorb® Media. (1"–12 UNF Thread)

Adaptors

Part No.	Material	Description	Fuel Ports	Nose	Use With
50181	Aluminum	Single Adaptor	3/4" NPT	1"–12 UNF	All Above
50003	Cast-Iron	Single Adaptor	3/4" NPT	1"–12 UNF	All Above
50002	Cast-Iron	Single Adaptor	1" NPT	1"–12 UNF	All Above
50005	Aluminum	Single Adaptor	1 1/2" NPT	1"–12 UNF	All Above
50006	Aluminum	Double Adaptor	1 1/2" NPT	1"–12 UNF	All Above
50015	Cast-Iron	Single Adaptor	1 1/2" NPT	1"–12 UNF	All Above

Replacement Gasket

Part No.	Description
90025	Buna-N Pre-Lubed Gasket Used On All Above

400HS

Application

- Water detection and particulate removal which reduces flow substantially to indicate water contamination
- Compatible with gasoline, diesel, and ultra-low sulfur diesel (ULSD)
- Designed for gasoline or diesel service station pumps, commercial fueling dispensers, and most Gilbarco Service Station dispensers

Design Features

- 25 gpm (94.6 lpm) maximum flow
- 50 psi (3.4 bar) maximum working pressure
- 10 micron and 30 micron Hydrosorb available
- Designed to detect free water, emulsified water, and filter particulates
- Pre-Lubed Gaskets standard

Benefits

- Monitors water content of storage tank
- Added protection to gasoline dispenser meter chambers
- Recognized by the Underwriters Laboratory (UL®) for use with service station pumps and dispensers
- Ease of installation with Pre-Lubed Gaskets

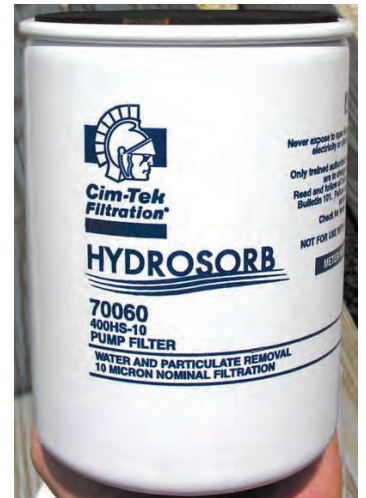

Ordering Information

Part No.	Model No.	Description
70060	400HS-10	Spin-On Filter for Water Detection and Particulate Removal with 10 Micron Hydrosorb Media. (1 1/2"-16 UNF Thread)
70065	400HS-30	Spin-On Filter for Water Detection and Particulate Removal with 30 Micron Hydrosorb Media. (1 1/2"-16 UNF Thread)

Adaptor

Part No.	Material	Description	Fuel Ports	Nose	Use With
50032	Aluminum	Single Adaptor	1" NPT	1 1/2"-16 UNF	All Above

Replacement Gasket

Part No.	Description
90036	Buna-N Pre-Lubed Gasket Used On All Above

FLEXSTEEL FUTURA

Superior, Long-Lasting Service with Multi-Fuel Capability

The new FLEXSTEEL FUTURA is the future of gasoline dispensing hose. FUTURA's cover is comprised of the innovative new Futurin compound — making it incredibly resistant to ozone cracking and wear.

- New Futurin synthetic rubber cover
- Nitrile synthetic rubber tube
- Hardwall wire braid reinforcement
- For use with gasoline, diesel, ethanol blends (E85) and biodiesel blends (up to B20)
- UL 87A approval pending

Why FLEXSTEEL FUTURA?

Our most ozone-resistant hose to date has performance advantages above and beyond FLEXSTEEL Hardwall, the best selling hose in the industry.

- Extraordinarily resistant to ozone cracking and wear
- Cover retains colors better with higher gloss
- Multi-fuel dispensing hose requires less inventory
- Quality hose construction, quality assemblies
- Advanced Futurin Compounding



A proprietary process using exclusive elastomer advancements has yielded Futurin, the revolutionary new rubber compound material that is incredibly ozone-resistant, color-fast and unlike anything ever seen in the petroleum dispensing hose industry.

ID		NOM. OD		WEIGHT	
in.	mm.	in.	mm.	lb./ft.	kg/m.
5/8	15.9	1.00	25.4	0.38	0.57
3/4	19.1	1.13	28.7	0.43	0.64
1	25.4	1.38	35.1	0.58	0.86

405 W Series

Particulate removing and water sensing



405 W-AD Series

Particulate removing and water sensing



405 P Series

Particulate removing



405 P-AD Series

Particulate removing



405 D Series Dual Purpose

Removes particulates, detects phase separation and water sensing



405 D-AD Series Dual Purpose

Detects and reacts to phase separation in ethanol blended fuels. Senses water in neat gasoline



Vacuums



Features

- 18 Gauge Polished Stainless Steel
- 4 Bag Filter System provides for longer motor life than conventional 2 bag system
- 2 - 1.7 H.P. Vac Motors
- Adjustable Timers
- High Security Pin Lock System
- 3/4 H.P. Thomas Compressor (air-vacuum models only)
- Vacuums are equipped with 15' x 2" Clog/Crush Resistant Hose and Nozzle
- Air-Vacuums are equipped with 25' Regular hose and Air Gauge

Power

Each service door is fitted with two stainless steel compression latches to keep the vacuum at maximum power level in case of door gasket wear.

Options

- Lock Bar System for Extra Security
- Cut resistant Hose (availability on air-vacuum only)

Model	Compressor HP	Vacuum Peak HP	CFM 2 1/2 Orifice	Electrical Rating	Shipping Weight
K52	n/a	1.7 each	109	9 amps (ea. motor) 120V	150 lbs.
K552	3/4	1.7 each	109	9 amps (ea. motor) 120V	200 lbs.



Features

- 16 Gauge Polished Stainless Steel
- 4 Bag Filter System provides for longer motor life than conventional 2 bag system
- 2 - 1.7 H.P. Vac Motors: exhaust is expelled 9" below the dome, to insure quality air for ventilation and cooling of motors
- Adjustable Timers
- High Security Medeco Plug Locks
- 3/4 H.P. Gast Compressor (air-vacuum models only)
- Vacuums are equipped with 15' x 2" Clog/Crush Resistant Hose and Nozzle
- Air-Vacuums are equipped with 25' Regular hose and Air Gauge

Power

Each service door is fitted with two stainless steel compression latches to keep the vacuum at maximum power level in case of door gasket wear.

Options

- JB-7 coin drawers available
- Cut Resistant Hose (available on-air vacuums only)
- 3/4 H.P. Thomas Compressor (air-vacuums only)
- Extra Heavy Duty Coin Door

Model	Compressor HP	Vacuum Peak HP	CFM 2 1/2 Orifice	Electrical Rating	Shipping Weight
K52	n/a	1.7 each	109	9 amps (ea. motor) 120V	150 lbs.
K552	3/4	1.7 each	109	9 amps (ea. motor) 120V	200 lbs.



LIQUIFIED PETROLEUM GAS AND AMMONIUM EQUIPMENT



Regulators & Accessories

LV3403TR, LV4403TR, LV4403B, LV4403B66RA, LV5503B, LV4403Y and LV5503Y, LV5503G4, LV6503B, LV404B4 and LV404B9, LV404B34 and LV404B39, 7525B, LV404Y9, 5807, 5808 and 5820, 5828 and 5832, 5726B34, 5727B34, 5754B4 & 5755b4, 302, 597F, 1580M, X1584V and X1586V, 3139, 912 and 913, Inlet Fittings, Brackets, Manifolds, Accessories, Test Kits



Cylinder & Service Valves

9103, 9103T9F, 9105C0, 9107K8A, 8556, 901 9101 and 9102 Series, 901C 9101H 9101Y, 9101P5 and 9101P6, 9104P, 901-400 and 903-400



Multivalve Assemblies

G8475R, 8593AR, 8555DL, 6555R, 8555D and 8555R, 6532, 6533, 6542 and 6543, PT6542 & PT6543, 7556R, PG8475 and PT7556



Pressure Relief Valves & Relief Valve Assemblies

A8434 and A8436, 8543 and 8544, 8545AK, 7583, 8684 and 8685, AA3126, AA3130, 3131, 3132, 3133, 3135, AA3135 and A3149, 3127 and 3129, SS8002 SS8021, 8542, Multiport



Globe & Angle Valves

A7793A and A7797A, A7707L and A7708L, 7554, 7053t A7553A and 7901T, 7500, 7704, 7705 and 7706, 7550 and 7551, TA7894P, A8016DBC, A8017D and A8020D, A8018DP



Excess Flow Valves, Check, Filler & Vapor Equalizing Valves

1519C, 1519A, 1519B and A1519, 3272, 3282 and 3292, A7537, A7539, A8523 and A8525, A2137 and 2139, A3500 and A4500, 2723C and A8013D, 3199W, 2884D, 7590U and 7591U, 7590U-20, Adapters, 7580F, L6579, 579 and 7579, 7647, 7579S, 6587EC and 3197C, 3174C, 3194C and 6584C, 7573 and 3183AC, 3170, A3198S, 3146, 3176, A3186, A3187S, A3196, and A3276BC, 6586D and A6586D, A3400L4 and A3400L6



Internal Valves & Accessories

A3209D and A3209DT, A3211D, A3217A and A3217DA, A3219, A3219RT, 3200C and 3200L, A3213R, A3212, Flomatic® A7883FK and A7884FK, A7853A



Adapters, Connectors & Fittings

A7571 and A7575, 3171, 3175, 3181, 3185 and 3195, 7141, 3119A and 3120, 3179B and 7577V, Acme Plugs, POL Plugs, Copper Pigtails, 5769HVB, 6588LE and 6589LE, 7576



Miscellaneous Equipment

(Including Rotogages & ESVs)

A9090, 2070, A2141, 6016 and 6024, 6010, ESV Pneumatic Controls, 7194, A7794 and A7796, 7193D-10 and 7193U-10, 7193T-10, 7193L-10A, 7193K-10B, A2805C, 12802, 3165C, 3165S and TSS3169, 3165, TA3169F, Pressure Gauges, 1224, 1316 and 1318



Commercial & Industrial Low Pressure

CS200 Series Pressure Reducing Regulators for LP-Gas Service Fisher CS200 Series direct-operated, spring-loaded regulators have been engineered to fit a multitude of pressure-reducing applications. This flexibility is provided by the numerous body sizes and outlet pressure settings.

.....



CS400 Series Pressure Reducing Regulators for LP-Gas Service Fisher CS400 Series direct-operated, spring-loaded regulators have been engineered to fit a multitude of pressure-reducing applications including commercial and light industrial installations.

.....



CS800 Series Pressure Reducing Regulators for LP-Gas Service CS800 Series direct-operated, spring-loaded regulators have been engineered to fit a multitude of commercial and industrial pressure-reducing applications.

.....



299H Pressure Reducing Regulators Fisher 299H high capacity pilot-operated regulators incorporates a light weight design with dependable operation.

.....



99 Series Commercial/Industrial Regulators Fisher Type 99 pilot-operated unit keeps outlet pressure constant despite varying flow rates and inlet pressures used for low or high pressure.

.....



133 Series Second-Stage Regulators Fisher Type 133 is self-operated second-stage regulator for either low pressure or pounds service.



HB Series Portable Beam Mechanical Scales

The CHATILLON® HB-1000 Series portable platform scale features a rugged cast-iron construction with corrosion-resistant loops, bearings and noise irons, making it ideal for industrial plants, warehouses and terminals. The HB-1000 meets the requirements for Handbook 44 Class III and is suitable for "Legal for Trade" applications. The HB-1000 features a large 18 x 17-inch (457 x 685 mm) platform. The graduated beam may be read from both sides. Graduations are black on a matte background. Weight is read from the center of poise. Wheels enable you to move the scale to different locations.



50#, 60# & 100# DOT CYLINDER



Screw Cap Type



Collar Type



Footring
Rust resistant
mastic coating



Catalog #	Product Data Description	Propane Capacities		Water Capacity Lb	Length OL In	Height H In	Diameter D In	Diameter B In	Tare Weight Lb	Skid Quantity
		Lb	Gal							
14990TC	50# POL VALVE VERTICAL - GRAY	50.0	11.4	119.0	27.4	21.8	15.1	14.0	42	27
1426TC	60# POL VALVE VERTICAL - GRAY	60.0	13.7	143.0	43.1	37.4	12.2	12.2	46	24
1428	100# POL VALVE VERTICAL - GRAY	100.0	22.9	238.0	46.6	41.0	15.1	14.0	70	18
1430	100# POL VALVE VERTICAL GRAY - WITH SCREW CAP	100.0	22.9	238.0	46.6	41.0	15.1	14.0	72	18
1436	100# MULTIVALVE VERTICAL - GRAY	100.0	22.9	238.0	46.6	41.0	15.1	14.0	71	18
1439	100# POL VALVE VERTICAL - GRAY COLLAR W/ LIQUID VALVE	100.0	22.9	238.0	46.6	41.0	15.1	14.0	71	18

100#, 200# & 420# ASME CYLINDER



- The DOT 200#, 420# and ASME 100#, 200# & 420# cylinders can be transported with 80% of total container volume.
- The weight of an ASME 420# is 13 lbs. more than a DOT 420#. This thicker steel provides the customer greater longevity of the 420# assets.
- ASME code does not mandate a retest period. DOT retest periods are 12 years after manufacturing, then each 5 year period thereafter.
- State-of-the-art powder coating system cylinder finish, called "Armor Clad II - THE NEXT GENERATION," which improves the durability of the tank by 150%!
- Vacuum Pre-purged tank saves in the cost to prepare a tank for customer use.
- HDPE (High Density Polyethylene) Lids. Extremely durable rust-proof and dent-proof. So reliable, they come with a 10 year guarantee!
- Lifting Lugs standard on 200# & 420#

20#, 33.5# & 43.5# Steel Forklift Cylinders

- Quick Coupler installed on all Manchester forklift cylinders.
- Cylinders can be stamped with your company name at no extra charge for skid quantity orders.
- Manchester forklift cylinders have Lifetime Warranty on dip tubes.
- Permanently positioned relief valve with a clear path to the outside of the cylinder. No adapters, which can be lost or misdirected, are needed.
- Foot ring designed to withstand high impact.
- Stackable for increased capacity on your trucks.



Quality Steel Propane Tanks



Tank Size (in gallons)	120	150	250	320	475	500	1000
Dimensions	24x67	24x82	30x92	30x114	37x113	37x120	41x190
Approximate Weight (in pounds)	260	380	480	620	920	940	1800
Shell Thickness	0.140	0.140	0.175	0.175	0.218	0.218	0.238
Head Thickness	0.138	0.138	0.148	0.148	0.184	0.184	0.201
Leg Width	2.5	2.5	2.5	2.5	3	3	3
Leg Distance from Edge of Shell	6.5	2.75	1.75	6	4	4	4
Leg Distance from Center to Center	34.5	59	60	60	60	60	141.5
Shell Width	50	67	64	87	75	81	149

Liquid Level Gauges

The 6300 Series Magnetel™ liquid-level gauges are designed to accurately determine the percentage of total tank volume for most liquids in stationary-storage applications. UL listed for LP Gas and NH₃ service.

These Gauges are available in four basic models:

- Incorporates 4" [100 mm] dial and is designed for top mounting.
- Incorporates 8" [200 mm] dial and is designed for top mounting.
- Incorporates 4" [100 mm] dial and is designed for side, end or angle mounting.
- Incorporates an 8" [200 mm] dial and is designed for side, end or angle mounting.



Accufueler-LP Classic

Accufueler-LP Classic is comprised of a combination of the simplest and easiest to service hydraulics, combined with stable and proven electronics from Gilbarco service station dispensers.

Hydraulic highlights:

- Liquatech model LPM102 meter
- Welded steel, one piece inlet manifold
- Piloted solenoids for flow control
- RegO bleeder and relief valves
- RegO safety breakaway valves
- 3/4" X 12 ft LPG hoses as standard

Electronic highlights:

- Gilbarco standard electronics
- Electronic calibration
- Gilbarco two-wire communications interface
- Compatibility with all Gilbarco POS systems

To further personalize the Accufueler-LP Classic to your needs, there are many options available to meet any specific dispensing needs. Among the options you can choose from:

- Various nozzles for light vehicle fueling, bus fueling and country-specific requirements
- Industry standard, mechanical temperature compensation on the meter
- Electronic customer programmable presets



LPG Dispensers

Multimedia LPG Dispenser

Eurostar En-SM Series



Multimedia LPG Dispenser

Eurostar Tn-XM Series



Stainless Steel LPG Dispenser

EUROSTAR En-SL Series



Painted LPG Dispenser

EUROSTAR En-SL Series



High Tower LPG Dispenser

EUROSTAR Tn-SL Series



Wide Frame LPG Dispenser

EUROSTAR Tn-XL Series



Mini LPG Dispenser





METERS



Liquid Controls Positive Displacement Flow Meters & Accessories

Meters provide exceptionally accurate service when using Liquid Controls' unique positive displacement metering principle, even under variable operating conditions (changes in temperature, pressure and viscosity). Provides the energy efficient and functional performance desired from an economical volumetric measuring instrument. Available with traditional mechanical seal or glandless magnetic driven pulse output device. A wide range of accessories are available to meet almost every metering need.

.....



LectroCount family of Electronic Registers

LectroCount® is Liquid Controls' series of electronic registers that replaces the mechanical register, calibration gears and/or adjuster mechanism traditionally used on many flow meters. The LectroCount® series are Weights & Measures (custody transfer) approved advanced microprocessor based electronic register, presetting and printing control systems. LectroCount® is designed to meet - even adapt to - your flow meter and process control instrumentation requirements. Units are design to NEMA-4x non-incendive Class 1, Division 2, Group C & D. LectroCount® accepts pulse input from most flow meters and includes RS232/485 communications capability. The LCR-II is also available in a design for Class 1, Division 1 environments.

.....



Mobile Computing DMS-Data Management System

The DMS In-Cab Data Management System is a flexible, industry specific mobile computing platform. The DMS provides users with the ability to connect to up to three Lectro Count registers, control them, capture and store transaction data and combine that information with customer data to print application specific tickets. All transaction data is stored and transferred to the office using a USB memory stick. There are several software applications that can operate on a DMS, each with functionality specific to the unique needs of different industries.



LCMag Electromagnetic Flow Meters

The LCMag family of electromagnetic flow meters offers the best solution for measuring the flow of electrically conductive liquids ($5\mu\text{S}/\text{cm}$ minimum). The sensor consists of a stainless steel pipe section internally lined with insulating material. PTFE, Polypropylene and Ebonite (hard rubber) liners are available. The two electrodes are positioned opposite each other on the internal surface of the pipe. The coils which generate the magnetic field are placed outside the pipe. The complete sensor has an external NEMA 6-6P (IP67/68) protection rating which guarantees the integrity of the magnetic circuit and protects the instrument against the external environment. The choice of materials in contact with the fluid (lining, electrodes, etc.) depends on the temperature, the chemical aggressiveness of the liquid and the degree of abrasion of the liquid.



Sponsler Precision Turbine Flow Meters

- High Resolution
- Simple Installation
- Compact Design
- Low Pressure Drop
- Variety of End Fittings
- Wide Flow Range
- Low Maintenance Cost
- Available with a wide variety of outputs (Transmitters, IT400, T675)



Mechanical Registers, Printers, Presets & TVCs

Check out electronic solutions from Liquid Controls to reduce maintenance costs, improve accuracy, reduce lost product due to shrinkage, improve delivery times and increase staff efficiency. From mobile computing solutions such as the DMS i1000 to electronic registration such as the LectroCount™ family including the LCR-II and new LCR 600.



LPM-102

Designed for retail sales dispensing units, the LPM-102 offers the widest flow range available in a meter of this type.

- Vapor Eliminator
- Strainer
- Differential Valve
- Optional Trac-bearing or Low-Flow Chamber



Neptune Type 4D Flowmeters

1-1/2" and 1-1/4" Type 4D meters, with double case design, have been specifically designed for the custody transfer of Liquefied Propane & Butane Gas (LPG).



Neptune Type MP Oscillating Piston Flowmeter

The Type MP Oscillating Piston Flowmeter provides high accuracy industrial liquids flow measurement.



Neptune 4-MT Petroleum Tank Truck Meter

The Neptune 2" Type 4-MT is an excellent choice for truck mounted metering of liquid petroleum products. The 2" aluminum body flowmeter comes complete and ready for installation and is ideal for both single and multi-meter applications.



Neptune 4D-MT LPG Tank Truck Meter

The Neptune 2" LPG meter is the worldwide standard for truck mounted metering. The aluminum body flowmeter comes complete and ready for installation. The 2" Type 4D-MT meter for Liquefied Propane Gas features a flanged outlet with ductile iron companion flange for easy installation and removal. The 2" Type 4D-MT is 33% lighter in weight than the old 2" Type 4D.



Neptune 4D-MD Meter for LPG Dispensers

The Neptune 1" Type 4D-MD meter has been specifically designed for the custody transfer of Liquefied Propane and Butane gas (LPG). This meter utilizes the oscillating piston positive displacement principle.



Neptune Type 4 Flowmeters

Neptune 1-1/4" and 1-1/2" Type 4 compact flowmeters are superb instruments for small and medium capacity tank truck metering.



Neptune Type 40 Flowmeters

Neptune 1-1/4" and 1-1/2" Type 40 flowmeters provide the accuracy and convenience you need in measuring refined petroleum products and allow you to control cost, loss prevention and invoicing.



Very Low Flow Flowmeters

VLF (very low flow) flowmeters have been designed to measure the flow of light fuel or diesel oil, for example, in applications such as measuring fuel oil consumption at large boiler plants, in a diesel engine generator and on engine test rigs.



Metrology Commercial

Sensus offers industry leading technology with commercial water meter product lines that provide utilities the opportunity to measure enhanced flow ranges and drive revenue.

Sensus' new metrology products comply with and exceed requirements set by The Safe Drinking Water Act and NSF/ANSI 61 Annex F and G that became standard in 2012.

accuMAG

The accuMAG meter is based on electromagnetic flow (EMF) technology and provides measurement of a wide flow range. With no moving parts, the accuMAG meter maintains its accuracy over its lifetime. AMR/AMI connectivity, reduced headloss, and field replaceable batteries are just a few of the key benefits of the accuMAG meter.



Mainline Propeller

Available in weld-on, clamp-on, plain tube and flanged end styles for applications where accountability rather than revenue is a factor. Typical applications include pump discharge, fresh water treatment plant measurement, sewage treatment plant effluent and chemical feed control. Available with Electronic Rate of Flow (E-ROFI) registers.



OMNI Compound (C2)

The OMNI meter is the most technologically advanced large water meter on the market today. The key to this optimal measurement performance is the application of the new Floating Ball Technology (FBT). FBT employs an impeller with a ball design which makes the impeller weightless in the water line. The technology enables the impeller to begin moving with very little water flow or force through the meter.

The measurement principles of the C2 meter assure enhanced accuracy ranges and a longer service life than any other comparable class meter. The C2 meter has no restrictions as to sustained flow rates within its continuous operating range.



OMNI Fireline (F2)

The F2 meter is ideal for use in limited vault space situations to service lines supplying both fire protection and domestic water. The F2 attacks head-loss and maintenance issues. The product is Underwriters Laboratories (UL) Listed and Factory Mutual (FM) approved.



OMNI Turbo (T2)

The T2 meter assembly maintains peak performance capability and continuous operation up to the rated maximum capacity flows without affecting long-term accuracy or causing any unwarranted component wear. The meter assembly also provides a 25% flow capacity in excess of the maximum flows listed for intermittent flow demands.



R-275, 415 and Cubix

Sensus domestic/residential meters incorporate the latest design concepts with modern materials for lighter weight, more durable meters with greater life expectancy.

The Cubix250 is based on a Sensus international gas meter design that boasts more than 10 million units in service throughout the Europe and Asia. The North American version meets utility standards and offers the same connection and index options as our larger residential-class meters – at a smaller size and cost.

The revolutionary accuWAVE diaphragm is reestablishing Sensus as the leader in residential-class meter accuracy and long-term performance. The patented accuWAVE diaphragm, now standard on Sensus R-275, 315 and 415 series domestic meters, registers consumption with smooth precision while incorporating advanced materials that ensure proof stability over time.



M Series

Superior performance features:

- Low pressure drop—will operate on gravity flow or pump pressure.
- Sustained accuracy—no wear from metal-to-metal contact inside the measuring chamber means minimal deterioration in accuracy over time, fewer recalibrations, and longer service life. Meters conform to NIST and International Weights and Measures accuracy requirements.
- Wide temperature range—products can be metered accurately from -40° F (-40° C) to 160° F (71° C).
- Wide viscosity range—LC meters can accurately meter products from less than 30 SSU (less than 1 centipoise) to 1,500,000 SSU (325,000 centipoise).
- Maximum adaptability—right angle design with choice of stock or custom elbows/fittings provides unequalled mounting flexibility to meet your installation requirements.



Model	Flange size	Max. nom. flow rate	Working pressure	Net weight
M-5	1½" or 2"	60 GPM 227 L/min	150 PSI 10.5 BAR	14 lbs 6.4 kg
M-7	1½" or 2"	100 GPM 380 L/min	150 PSI 10.5 BAR	19 lbs 8.6 kg
M-10	2"	150 GPM 550 L/min	150 PSI 10.5 BAR	19 lbs 8.6 kg
M-15	3" or 3" in, 2" out	200 GPM 760 L/min	150 PSI 10.5 BAR	37 lbs 16.8 kg
M-25	3"	300 GPM 1100 L/min	150 PSI 10.5 BAR	37 lbs 16.8 kg
M-30	3" or 4"	350 GPM 1325 L/min	150 PSI 10.5 BAR	120 lbs 54.4 kg
M-40	4"	450 GPM 1700 L/min	150 PSI 10.5 BAR	120 lbs 54.4 kg
M-60	4" or 6"	600 GPM 2270 L/min	275 PSI 19 BAR	201 lbs 91.2 kg
M-80	4" or 6"	800 GPM 3228 L/min	275 PSI 19 BAR	201 lbs 91.2 kg
MA-5	1½" or 2"	60 GPM 227 L/min	275 PSI 19 BAR	14 lbs 6.4 kg
MA-7	1½" or 2"	100 GPM 380 L/min	275 PSI 19 BAR	19 lbs 8.6 kg
MA-15	3" or 3" in, 2" out	200 GPM 760 L/min	275 PSI 19 BAR	37 lbs 16.8 kg

900DB Series

- 6-40 GPM (23-151 LPM)
- Gasoline, Diesel, BD up to B20, Kerosene, E15, Mineral Spirits, Stoddard Solvents and Heptanes Compatible
- +/- 1.25% Accuracy; Repeatability: +/-0.25%
- Maximum Pressure: 50 psi
- Rotates 90° for Vertical Applications
- 3/4" 4 Digit LCD Display w/ 7 Digit Resettable Totalizer
- Memory Backup for Protection Against Battery Power Failures
- Measures: English or Metric Plus User Defined Units
- ATEX, UL and cUL Certified



900DP Series

- 6-40 GPM (23-151 LPM)
- Gasoline, Diesel, BD up to B20, Kerosene, E15, Mineral Spirits, Stoddard Solvents and Heptanes Compatible
- +/- 1.25% Accuracy; Repeatability: +/-0.25%
- Maximum Pressure: 50 psi
- Rotates 90° for Vertical Applications
- 3/4" 4 Digit LCD Display w/ 7 Digit Resettable Totalizer
- Memory Backup for Protection Against Battery Power Failures
- Measures: English or Metric Plus User Defined Units
- ATEX, UL and cUL Certified



807C Series

- 5-20 GPM (19-75 LPM)
- 3 Wheel Mechanical
- +/- 1% Accuracy
- Measures Flow Left to Right
- Gasoline, Diesel, E15, Kerosene, B20 and Mineral Spirits Compatible
- Available in 3/4" or 1" Ports
- Also Available for Gravity Feed Applications - Model Number 806C



901 Series

- 6-40 GPM (23-151 LPM)
- 4 Wheel Mechanical
- +/- 2% Accuracy
- Left to Right Flow
- Gasoline, Diesel, Kerosene and Mineral Spirits Compatible
- Available in 1" or 1.5" Ports



807C Series

- 2-20 GPM (8-72 LPM)
- Digital LCD Display
- +/- 0.5% Accuracy
- Polypropylene Construction
- Compatible with most Automotive Fluids (except Gasoline) Mild Acids, Very Thick Fluids and Many Industrial Chemicals
- 1" Inlet and Outlet
- Measures: English or Metric Plus User Defined Units



Ultrasonic Flowmeters

QStar Series

QStar ultrasonic flowmeters operate according to the high-precision ultrasonic transit time difference method. Thanks to clamp-on technology, the ultrasonic transducers used can be installed in a matter of minutes. No need exists to cut or penetrate your pipes. This possibility, together with the elimination of process interruptions, means that QStar devices are the key to minimizing operating costs.



Turbine Flowmeters

G Series Precision Models

The G Series Precision turbine flowmeters for food and beverage, dairy, and pharmaceutical applications are the most accurate flow meters from GPI. In this 0.5%(half-percent) accuracy flowmeter line you will find flowmeters made out of stainless steel housings, flowmeters that read in both liters and gallons, and flowmeters that are half of a percent accurate. The G Series Precision turbine flowmeter line also includes flowmeters that will work with most chemicals and won't crumble when put through high pressure applications. These flowmeters come in NPT Taper, BSP, and ISO Taper fittings.



Turbine Flowmeters

G2 Series Industrial Grade Models

The G2 Series turbine flowmeters are intrinsically safe, cost-effective, ideal for monitoring, batching and for some process control applications. This why they remain the most popular GPI flowmeter. G2 Series flowmeters are suitable for any Class 1, Division 1 environment. These self-contained, compact flowmeters also feature an integrated display. These flowmeters come in stainless steel, aluminum, brass, pvc, and pvdf materials. The G2 Series flowmeters come in 150# ANSI Flange, ISO, NPT, Tri-Clover®, and Solvent Weld fittings.



Water Meters

TM Series Models

This economy water flowmeter is an ideal alternative to traditional water meters. The TM Series water meters offer flow rate and flow total indication that help monitor water flow in waste water applications, water treatment, and sub-metering applications. The battery powered electronic display TM Series water flowmeters are calibrated to read in gallons and liters per minute.

The new TM300 and TM400 electronic computer can read gallons, litres, and cubic feet. These water flowmeters also have two totals in which case one is resettable and the other gives you cumulative flow totals.



Fuel/Petroleum Flowmeters

A1 Series Commercial Grade Models

The A1 Series turbine flowmeters are the ideal economical flowmeters for monitoring fuel, petroleum, and non-aggressive chemicals. These economical flowmeters come in aluminum and nylon housings. The nylon flowmeter is widely used to measure water and the aluminum flowmeter to measure gasoline fuel. The A1 Series turbine flowmeters are designed as self-contained, battery powered units. The A1 series flowmeters come in NPT, ISO, and BSPP fittings.



Digital Flowmeters

Economy Models

Looking for economical flowmeters? The GPI economy electronic digital flowmeters are what you are looking for. These economy model flowmeters are great for basic flow monitoring. GPI manufactures various economical flowmeters that are good for measuring petroleum fuel, water, chemicals, harsh chemicals, engine oils, and transmission fluids. These economy flowmeters come in various fitting and connection types such as NPT, BSPT, Schedule 80 Soc, ISO, and BSPP. Check individual flowmeter models for their specific fitting type.



Flowmeter

Electronics and Modules

GPI flowmeter electronics include local and remote 4-20mA output, flowmeter batchers, flowmeter controllers, flowmeter scaled pulse, flowmeter pulse output with and without display. GPI also offers a wireless system to transmit flowmeter pulse signals to monitoring equipment. These electronic choices include explosion proof totalizer & rate indicators.



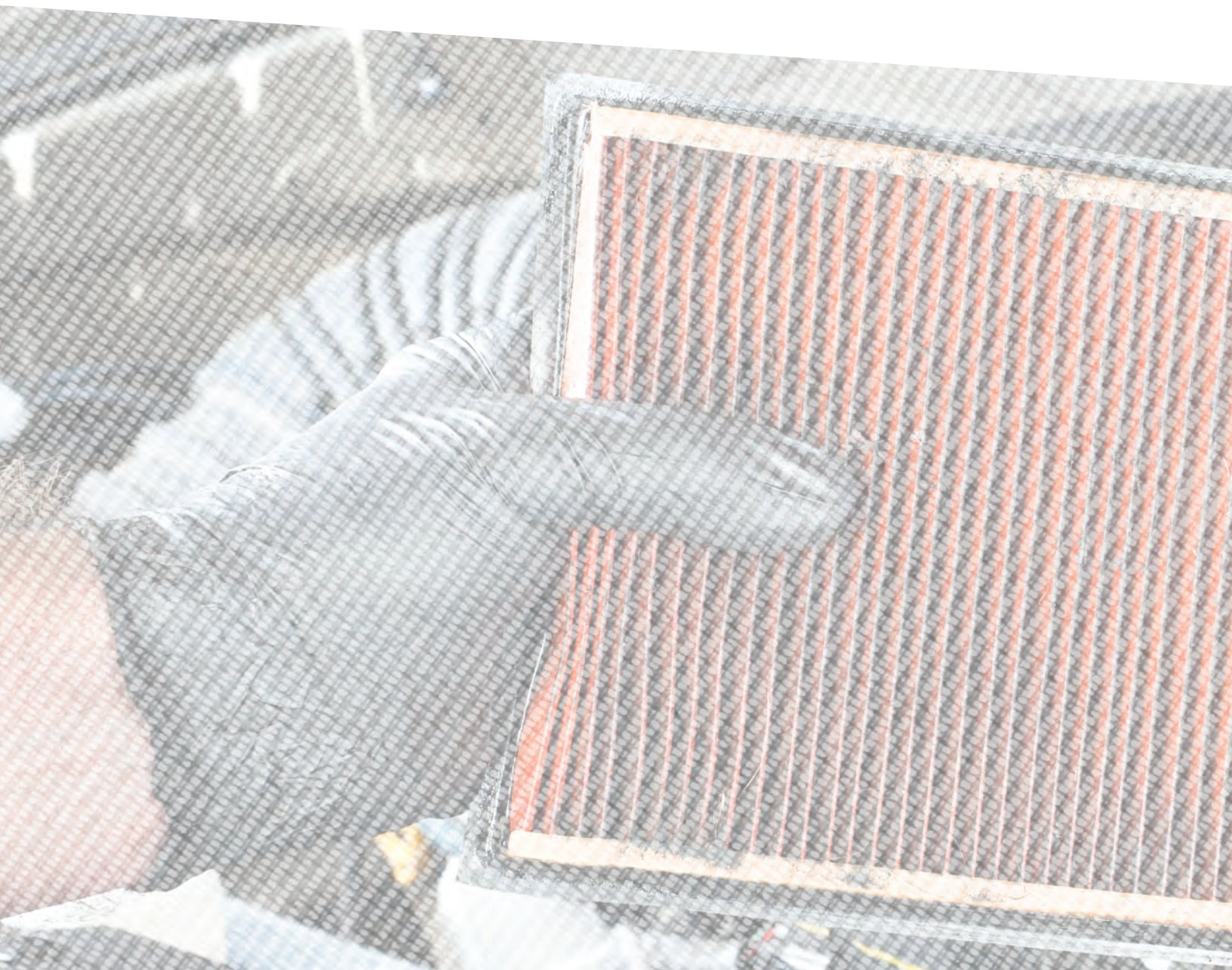

FILTERS

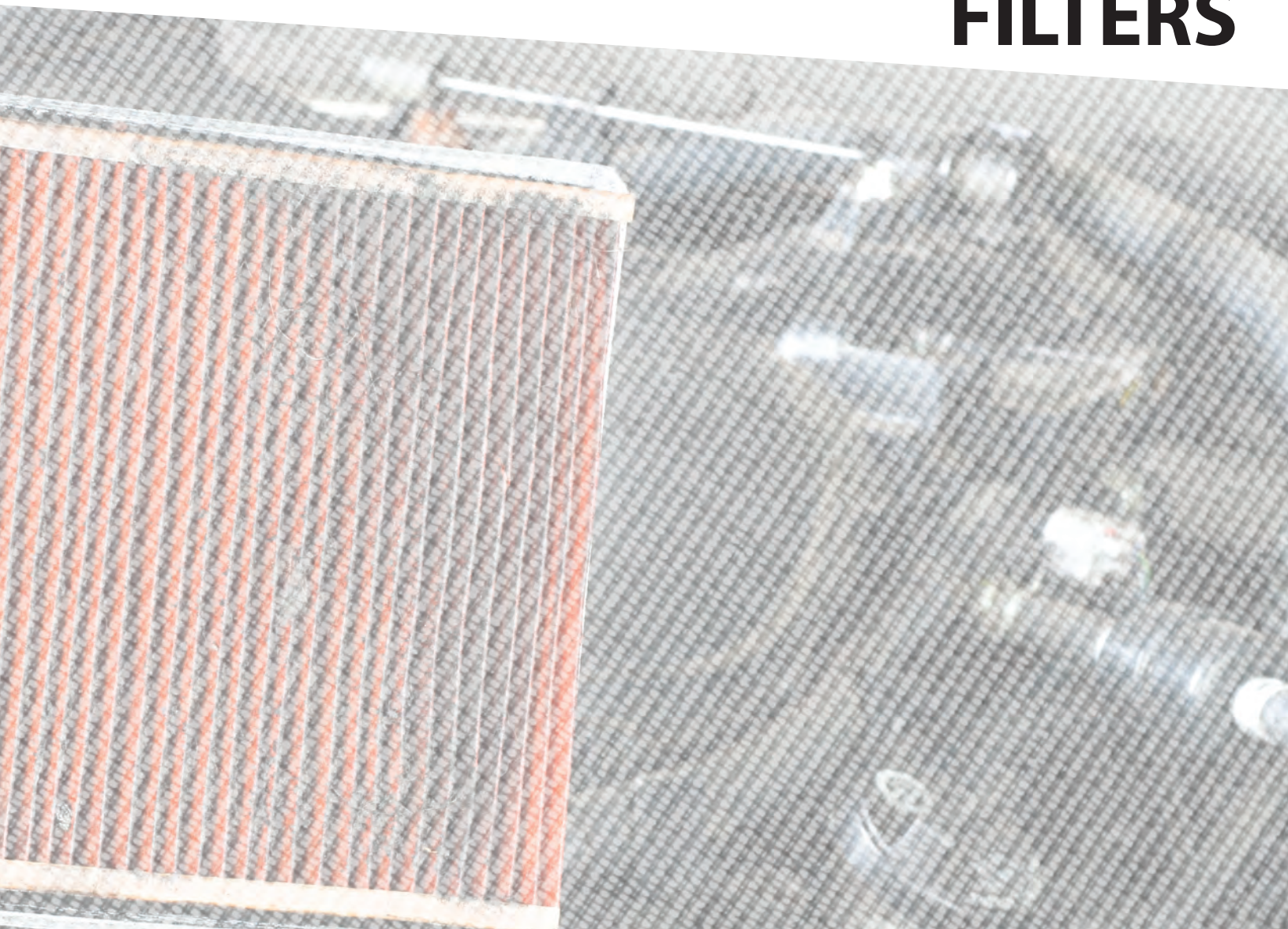

11M



Class 250 Cast Iron
Screwed End Y Strainers

125



Class 125 Cast Iron
Screwed End Simplex
Basket Strainers

125-B



Class 125 Cast Bronze
Screwed End Simplex
Basket Strainers

125-CS



Class 150 Cast Carbon
Steel Screwed End
Simplex Basket Strainers

125-SS



Class 150 Stainless Steel
Screwed End Simplex
Basket Strainers

125F-B



Class 150 Cast Bronze
Flanged End Basket
Type Strainers

125F-CI



Class 125 Cast Iron
Flanged End Basket
Type Strainers

125F-CS



Class 150 Cast Carbon
Steel Flanged End
Simplex Basket Strainers

125F-SS



Class 150 Stainless Steel
Flanged End Simplex
Basket Strainers

126F-CS



Class 300 Cast Carbon
Steel Flanged End
Simplex Basket Strainers

126F-SS



Class 300 Stainless Steel
Flanged End Simplex
Basket Strainers

155M



Class 125 Cast Iron
Flanged End Basket
Strainers, Clamped
Cover

Commercial Filters



Part#	Model	In/Out	GPM	# of Elements
40001	Centurion Single	1" NPT	30	1
40013	Centurion Double	1 1/2" NPT	60	2
40020	Centurion Triple	2" NPT	90	3

Applications:

- Designed for high-volume applications
- Housings and replacement elements are compatible with gasoline, diesel, ethanol blends up to 15%, biodiesel up to B20, and ultra-low sulfur diesel (ULSD)

Features:

- Up to 90 gpm/ 340 lpm maximum flow
- Elements available in 2, 10, and 20 micron cellulose for particulate removal
- Elements available in 10 and 30 micron Hydrosorb® for water detection and particulate removal
- Drain for easy water removal
- Parallel flow

Benefits:

- Extended equipment life
- Assures delivery of quality fuel
- Cleaner change-out with drain design
- Eco-friendly reusable housing

Centurion Elements

30065	E02	Cellulose Element	2 Micron
30002	E10	Cellulose Element	10 Micron
30004	E30	Cellulose Element	30 Micron
30195	E-10M	Microglass Element	10 Micron
30033	EHS-10	Hydrosorb® Element	10 Micron
30036	HS-300	Hydrosorb® Element	30 Micron

Bulk Filters



Part#	Model	In/Out	Diameter	Length	GPM	# of Elements
40001	Viking 1	2" NPT	12"	32 ½ "	120	1
40013	Viking 1F	Flanged	12"	32 ½ "	120	1
40020	Viking 2	2" NPT	12"	50 ½ "	150	2
40189	Viking 2F	Flanged	12"	50 ½ "	150	2
40190	Viking 3F	Flanged	24"	59 ¼ "	300	4
40191	Viking 4F	Flanged	28"	78 ½ "	500	8

Applications:

- Designed for bulk fluid transfer and fueling rack filtration
- Housings and replacement elements are compatible with gasoline, ethanol blends up to E15, biodiesel blends up to B100, diesel fuel, ultra-low sulfur diesel (ULSD), and fuel oils.
- Able to filter industrial fluids such as lubrication, hydraulic, synthetic oils, many solvents and thinners.

Features:

- Up to 500 gpm/ 1892.7 lpm maximum flow
- 150 psi rating
- Epoxy coating inside and out
- Carbon steel housing
- Gauge ports standard

Benefits:

- Extended equipment life
- Assures delivery of quality fuel
- Cleaner change-out with drain design
- Eco-friendly reusable housing

6" x 18" Elements

30066	E-1300-02	Cellulose Element	2 Micron
30008	E-1300-10	Cellulose Element	10 Micron
30009	E-1300-30	Cellulose Element	30 Micron
30204	E-1300MG-03	Microglass Element	10 Micron
30203	E-1300MG-05	Microglass Element	10 Micron
30202	E-1300MG-10	Microglass Element	30 Micron
30034	E-1300HS-10	Hydrosorb® Element	10 Micron
30037	E-1300HS-30	Hydrosorb® Element	30 Micron
30210	E-1300WM-44	Wire Mesh Element	144 Micron



Lubricators

Port size

- 1/8" NPTF
- 1/4" NPTF
- 3/8" NPTF
- 1/2" NPTF
- 3/4" NPTF
- 1" NPTF
- 1-1/4" NPTF
- 1-1/2" NPTF

LPG Filter

SP-100 and CT-100 filters help you to keep your LPG Dispenser's and other LPG equipment's life longer. Its cork can be produced as 10 microns to 18 microns according to customer request.



VF-61, VF-61E, VF-62 Clean Dry Fuels and Oils with High Performance Aquacon® Filter Cartridges

Features

- Free and emulsified water to less than 5 ppm
- 1/2 micrometer particulate removal
- Provides protection against "slugs" of water
- Pressure increase signals cartridge change
- Use with existing filter housings

Applications

Fuels
Jet Fuel
Avgas
Motor Gasoline
Diesel fuel
Biodiesel Fuel

Oils
Insulating Oil
Hydraulic Oil
Lubricating Oil
Selected Solvents



VF-61
with Optional
DP Gauge



VF-61E
with Band
Clamp Closure



VF-62
with Optional
Hand Knobs

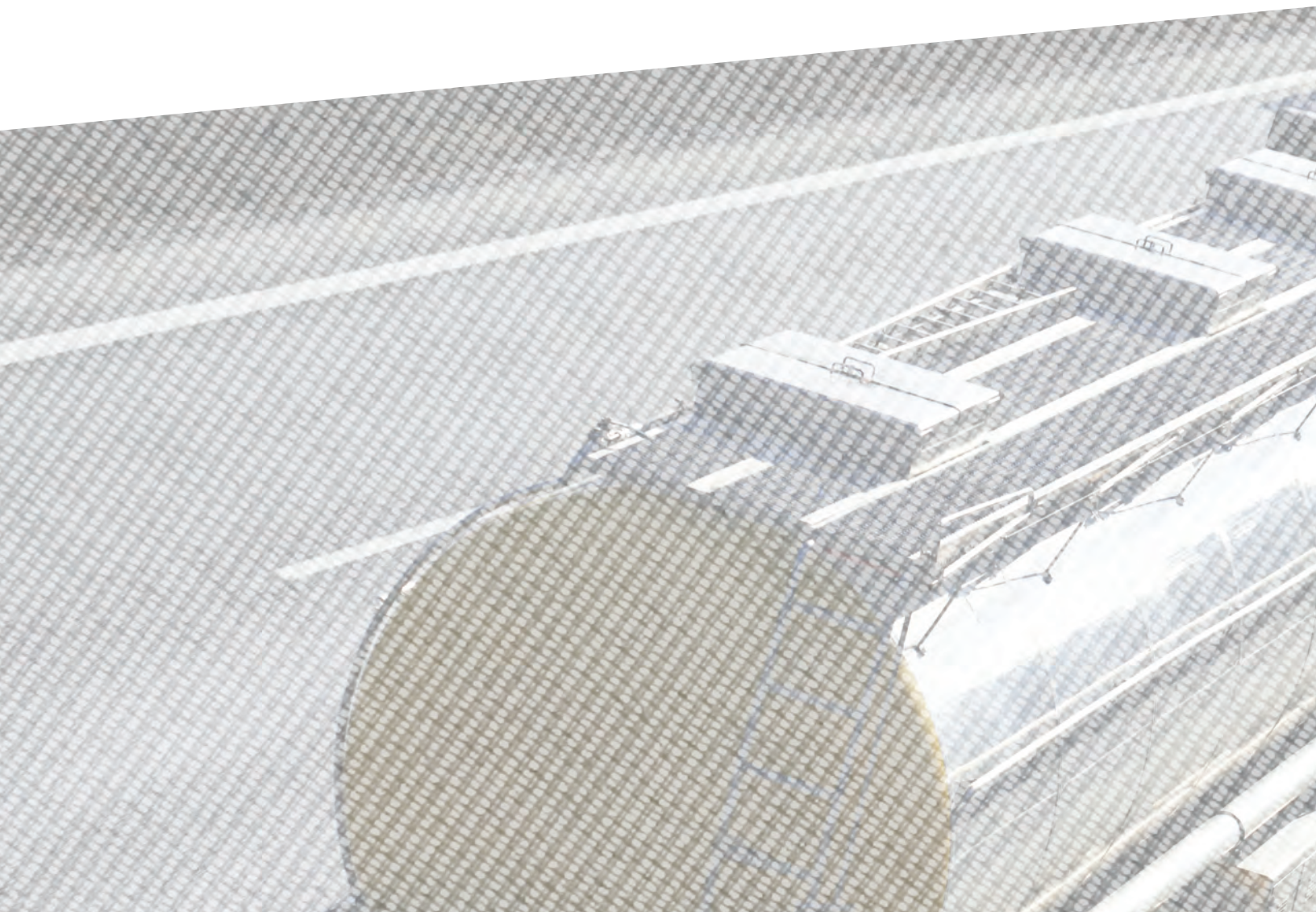

LOADING RACKS AND TANK TRUCK EQUIPMENT





Electronic Terminal Equipment

Scully's Electronic Terminal Systems provide Dynamic Self-Checking® overfill protection, as well as grounding verification for bottom loading terminals which load petroleum and liquid chemicals into tank trucks and rail tank cars. These systems are capable of controlling fills and eliminating spills of tanker trucks with up to 8 compartments when equipped with two-wire sensors or 15 compartment tanks when equipped with five-wire sensors. The systems work best with tank trucks and/or rail tanks outfitted with sensors pioneered by Scully.

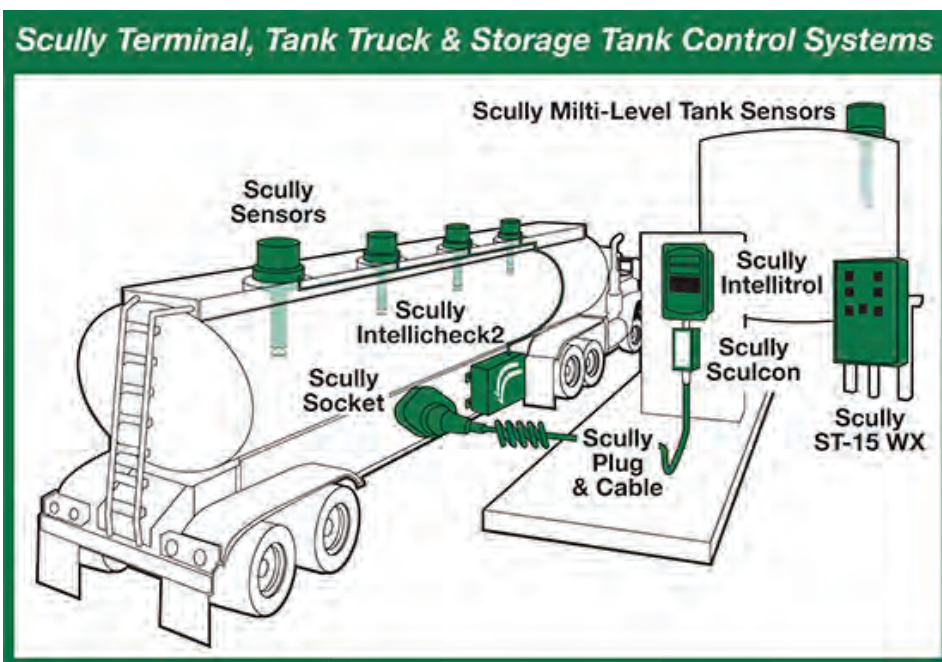

Loading Arms & Associated Products

We are the leading global provider of total solutions for customers needing to transfer or store hazardous gasses and liquids in bulk. We manufacture a variety of marine, road and rail loading arms as well as a comprehensive range of accessories. Our strong brand names include Emco Wheaton, Perolo, CE-LSI and AARIG are synonymous with product quality and customer satisfaction.



Loading Arm Accessories

We offer a wide range of accessories for our road and rail loading arms, from Control Systems to Telescopic Drop Tubes. Please select your required products from the list below, if you do not find the product you require, please do not hesitate to contact us.



Bottom Loading Arms

Bottom loading offers benefits which cannot be achieved with top loading designs. Bottom loading takes place on the ground, making it inherently safer for the operator. It also allows for simultaneous loading of several tank compartments, increasing speed and efficiency of loading. Bottom loading is easily adaptable to vapor recovery systems.



Marine Loading Arms

We design and manufacture a wide range of Marine Loading Arms to load and unload almost any liquid and compressed gas product from river barges, ships and ocean going super tankers. Pantograph balanced mechanical link technology provides the stability and strength for this most demanding task.



Specialty Loading Arms

Emco Wheaton engineers have developed a number of loading arms for specialized service applications. The loading arms listed in this section are examples of proven designs and have years of field use. If your application does not quite fit with any of the models listed in this section please contact us.

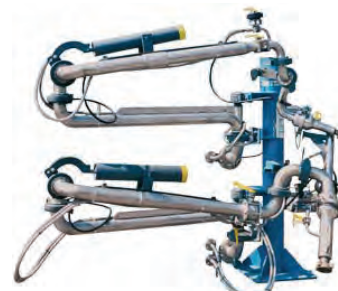

Top Loading Arms

We have been designing and manufacturing loading arms for over 50 years. Our focus on meeting the specific needs of our demanding customer base has resulted in us being able to offer technically advanced solutions to suit almost any application in the world. Our various designs allow us to handle virtually any liquid known to man in a safe and reliable manner. Our loading arms are available in carbon steel, carbon steel / aluminum, stainless steel, low temperature carbon steel, Hastelloy and Titanium. Lining with PTFE and vulcanized rubber can also be provided.

Mechanical Tank Truck



16" & 20" Petroleum Manholes



Vapor Recovery Vents, Adaptors, & Accessories



Internal Valves



Adapters



Manifold Systems



Air Controls



Product Delivery and Vapor Recovery Elbows



Control Box

Electrical Tank Truck



On Truck Overfill Systems



Autotemp



Probes



On Board Monitors



Cabling



Sockets



Control Box



Test Equipment

Float & Tape - Automatic Tank Gauging

- Installation kits and accessories for product compatibility and tank conditions
- Spare parts and maintenance kits to keep your gauge operating smoothly
- Tank gauge transmitters for level and temperature measurement integration and inventory control applications
- Additional support services, such as preventative maintenance programs and training classes



The 2500/2520 Automatic Tank Gauges are mechanically operated, float and tape instruments designed to provide continuous liquid level measurement in bulk storage applications.



The gauge board of the model 6700 can easily be seen from long distances and provides the simplest form of tank gauging.



A large float follows the level of the product as it moves up and down in the tank. The float is connected to a tape or wire that in turn is connected to an indicator.



2500 Automatic Tank Gauge (ATG)



2520 High Pressure Automatic Tank Gauge (ATG)



6700 Liquid Level Gauge

Loading Arms & Rack Equipment



Top Loading Arms

For top loading tank trucks, railcars, totes & drums.

- Fixed Reach Style Top Loading Arm
- Scissor Style Top Loading Arm
- Unsupported Boom Style Top Loading Arm
- Supported Boom Style Top Loading Arm
- Slide Sleeve Arm A-32-F



Bottom Loading Arms

For bottom loading tank trucks & railcars

- Unsupported Boom Bottom Loader
- A Frame Loader
- A Frame Hose Loader AFH-32-F
- CWH Series Counterweighted Hose Loader
- Short Range Hose Loader
- Long Range Hose Loader



Custom Loading Arms

- Vapor Recovery
- Steam Jacketed / Heated Applications
- Pneumatics – for push-button operation
- By-Pass Loading Arms – for handling corrosives
- Drum / Tote Loading



Safety Breakaway Coupling

For top loading tank trucks, railcars, totes & drums.

- NTS-PU (Direct Pull) Series
- NTS-SZ (Cable Release) Series



Loading System Accessories

For top loading tank trucks, railcars, totes & drums.

- Loading Arm Replacement Swivel Joints
- Loading Arm Counterbalance Assemblies
- Electronic Rack Monitor Equipment
- Safety Breakaway Couplings
- Quick & Dry Disconnects
- Vacuum Breakers
- Loading Arm Lockdowns
- Loading Arm Deflectors
- Loading Arm Strainers
- Loading Valves
- API Bottom Loading Couplers & Accessories

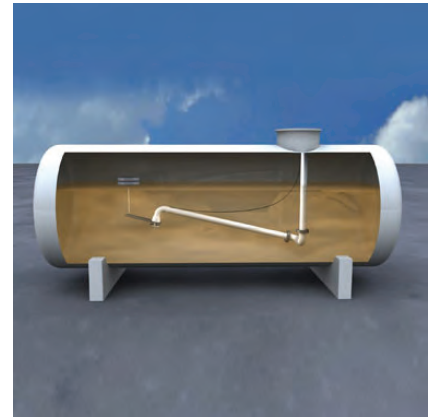

Floating Suctions

Composite Hose

Hose composites are engineered to deliver the maximum in chemical compatibility and on-the-job performance.

- Certified ISO 9001 composite hose manufacturer
- Manufactured to your specifications and shipped worldwide
- Manufactured from multiple tight-wound thermoplastic films and tubes that create a barrier to permeation.

Specialized manufacturing process techniques assures the proper gauge and pitch of the inner and outer wires to ensure conformity and consistency every time.

The result is a truly flexible thermoplastic composite hose that doesn't kink or collapse with exceptional service life and offers superior safety and performance.



TIFT Composite Hose

Hose composites are engineered to deliver the maximum in chemical compatibility and on-the-job performance.

- Certified ISO 9001 composite hose manufacturer
- Manufactured to your specifications and shipped worldwide
- Manufactured from multiple tight-wound thermoplastic films and tubes that create a barrier to permeation.

Specialized manufacturing process techniques assures the proper gauge and pitch of the inner and outer wires to ensure conformity and consistency every time.

The result is a truly flexible thermoplastic composite hose that doesn't kink or collapse with exceptional service life and offers superior safety and performance.

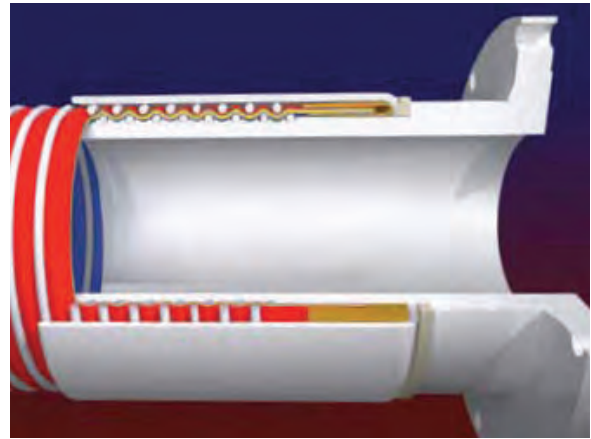

Mechanical Operator

- Heavy Duty Tubular Steel Levers
- Twice the Leverage of Universal Operators
- 2-1/2" Stroke
- Non-slip Cable Connectors
- Fusible Joint on Each Compartment

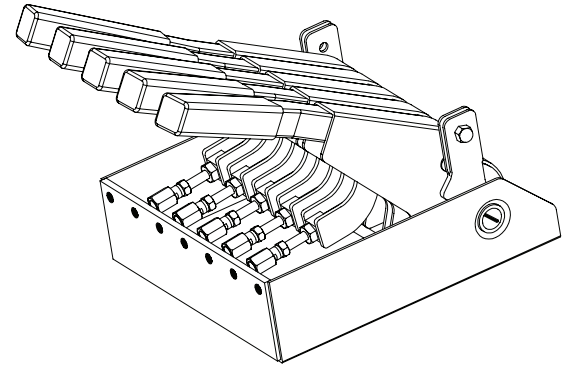

Emergency Valve Aluminum Flat Seat Style

- Air or Cable Operated
- Groove or Flange Outlet
- Buna Urethane or Viton Seals

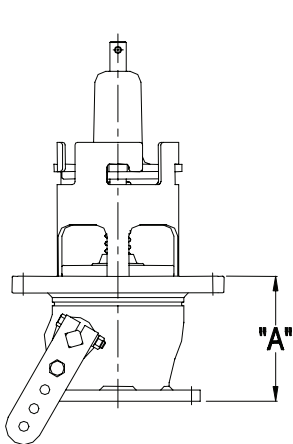

3in. CABLE / FLANGED

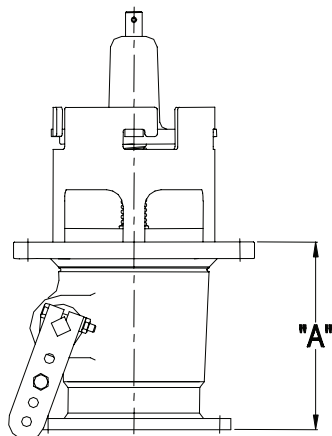

4in. CABLE / FLANGED

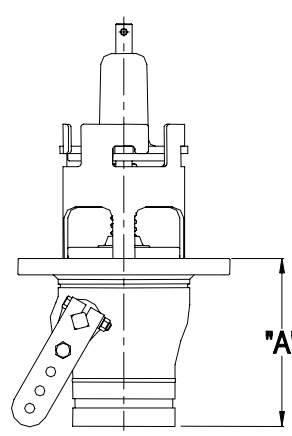

3in. AIR / GROOVED

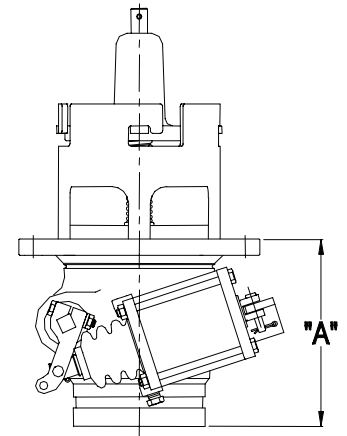

4in. AIR / GROOVED

Wet-R-Dri Valve

- Lightweight
- Compact
- Versatile

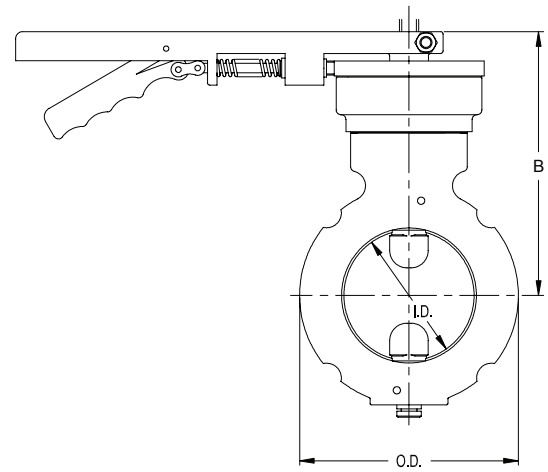

Gate Valve Fabricated Double Acting

- Flexible action of Stainless Steel Belleville Discs ensures a tighter valve over longer periods of time
- No elastomers to deteriorate
- Fabricated for greater strength, lighter weight and lower cost, in steel, stainless and aluminum
- Double acting hand stem threads double the speed of operation. Valve closes in half the time
- MAWP 50 PSI

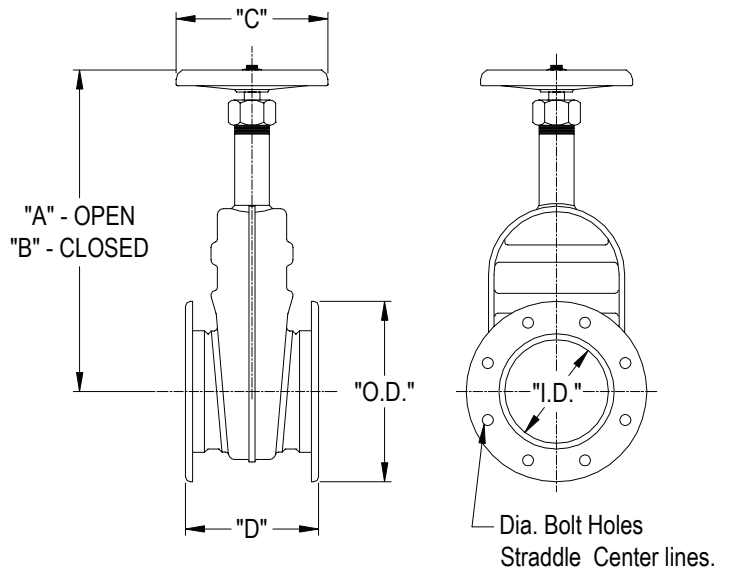

Model PAF450

Model PAF450 is a 10" spring loaded pressure relief valve (PRV) designed to provide pressure actuated emergency venting intended to relieve pressure build-up inside a cargo tank. The 10" PRV also serves as a latch style fill that can be easily opened to provide access for inspection or filling of the tank.

The PAF450 was legal for installation on US DOT MC306 cargo tanks prior to August 31, 1998. Per 49CFR180.405(h (3), a properly functioning PAF450 can be repaired and maintained but if the entire assembly needs to be replaced, a relief valve model that meets the less-than-1-liter surge leakage requirement of 49CFR178.345(b)(3)(ii) must be installed. The PAF450 can be installed on non-specification tanks or in tanks built and operated in countries where regulations permit.

The 10" PRV comes in two basic versions:

1. A 10" PRV attached to a flat manhole cover. This version requires the collar to be purchased separately and comes in many different manhole configurations.
2. A 10" PRV mounted directly to a 10" weld collar.

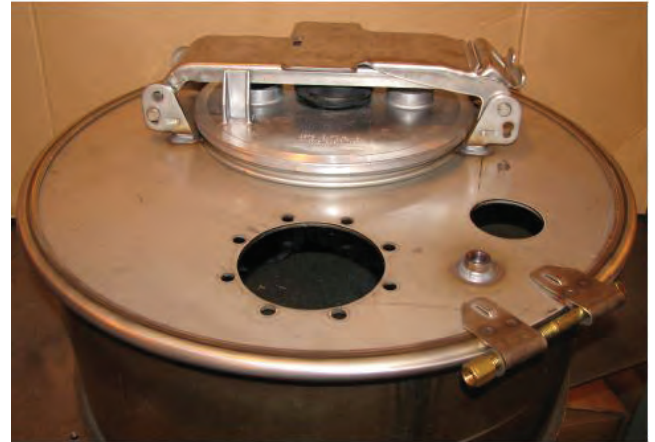

ASKW Series Radio Remote Fueling Controls

Up to 8 channels of bulletproof control. The industry standard in petrochemical applications including propane bobtails and refined fuels trucks. Range up to 1000 feet and battery life over 300 hours continuous transmission.



ProControl 2 Remote Readout with RFID

ProControl 2 takes radio remote control systems to the next level. This all-in-one controller can greatly improve delivery efficiency and reduce costly fueling mistakes. Easily retrofitted to existing trucks or installed on new equipment, this patented system is certified for use throughout the world.



Bulk Fuel Plant Wireless Emergency Shutdown

Wireless Emergency Shutoff system for bulk plant and industrial facilities. Eliminates expensive wiring, conduit, and labor needed to connect hard-wired shutoff switches. Includes test mode, low battery warning and optional solar charging.



Transport Leak Detection DCE Certified "Passive" System

An automatic leak detection and shut down system for LPG, Anhydrous Ammonia and Butane bulk transports. Trailer mounted unit monitors the off-loading process for broken or damaged hoses, fittings and piping.



Wireless Deadman Switch Radio Remote Fueling Controls

Wireless Deadman System utilizes spread spectrum, frequency-hopping radio technology that virtually eliminates interference-related signal loss. Up to twelve functions can be specified providing hose-end control of the deadman valve, hose reel, PTO, engine RPM, pump, meter and other truck equipment.



Crane Service Truck Proportional Hydraulic Radio Remote Controls

Variable speed toggle switch control. Features high/low range selector for precision movement. Up to 12 control functions with PWM interface to hydraulic system. Rechargeable batteries and range to 2000 feet.



Crane Service Truck Non-Proportional Hydraulic Radio Remote Controls

Up to 12 channels of On / Off control. Used on electric or hydraulic service trucks, cranes and other applications requiring interference-free control. Features rechargeable batteries, serial communication and up to 2000 feet range.



Driver Authorization System Bulk Truck Theft Prevention

The Driver Authorization System is designed specifically for Bulk Fuel Delivery Trucks. The system prevents unauthorized vehicle driveaway with or without engine running.



System Accessories & Replacement Parts

BASE offers a variety of machine interface hardware. These modular components have been engineered to 'quick-connect'.



BASEstation On Board Truck Computer

BASEstation is an on-board computer designed specifically for petroleum delivery fleets. Our truck mounted computer and back office connection were designed and built by people with 33 years experience in fuel delivery automation and control.



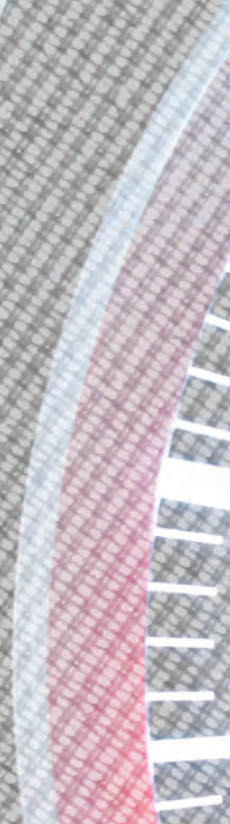
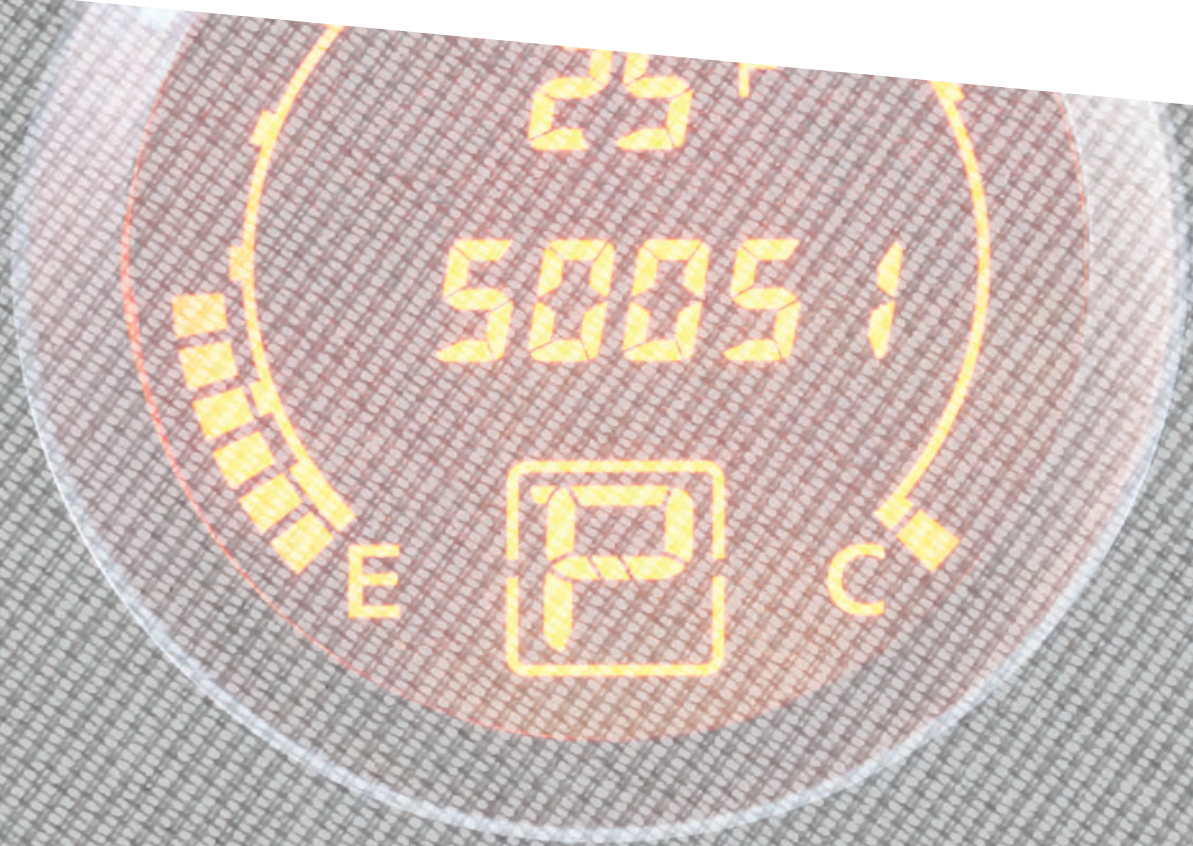

SERVICE
MESSAGE



MISCELLANEOUS



Air Preparation

When it comes to air preparation Norgren has evolved its experience and products for over 80 years. Familiar product brands such as Excelon and Olympian have a proven history throughout industries globally. From stand alone units utilized in paint spraying applications to multiple installations on trains, Norgren Air Preparation products deliver ultimate quality and reliability. Detailed specifications, CAD and datasheets can be available upon request. Please contact us for further support in selecting the right air preparation product for your application.



Combination units



Filters/Regulators



Filters



Lubricators



Pressure Regulators



Pressure Relief Valves



Soft Start Dump Valves



Mainline Series



Stainless Steel



Special Purpose Regulators



Lockout Valves

Process Gauges

PPC Process Gauge

Standard Dial Sizes

4.5"
(115mm)

Standard Ranges

4.5"
(115mm)

Socket

316L SS
Brass

Accuracy

±0.5%



P1S 100 Series Gauge

3.5"
(90mm)
4"
(100mm)
4.5"
(115mm)
6"
(150mm)

Vac to
5,000 PSI

Brass

±1%



P3S 300 Series Gauge

4.5"
(115mm)
6"
(150mm)
8.5"
(215mm)
10"
(250mm)

Vac to
20,000 PSI

316L SS

Brass

±0.5%



PFP Premium SS Liquid Filled Gauge

2.5"
(63mm)
4"
(100mm)
4.5"
(115mm)
6"
(150mm)

Vac to
20,000 PSI

316 SS
(4" welded)

Brass

2.5":
±1.5%
4", 6":
±1.0%



Economy Gauges

P9S 90 Series Gauge

Standard Dial Sizes
4.5"
(115mm)

Standard Ranges
4.5"
(115mm)

Socket
316L SS
Brass

Accuracy
±0.5%



PEU Economy Panel Mounted Gauge

3.5"
(90mm)
4"
(100mm)
4.5"
(115mm)
6"
(150mm)

Vac to
5,000 PSI

Brass

±1%



Sanitary Gauges

PAG 3A Food, Beverage, Dairy Sanitary Gauge

4.5"
(115mm)
6"
(150mm)
8.5"
(215mm)
10"
(250mm)

Vac to
20,000 PSI

316L SS
Brass

±0.5%



Compressed Gauges

PCG Compressed Gas Gauge

**Standard
Dial Sizes**

4.5"
(40mm)
2"
(50mm)

**Standard
Ranges**

0/30 to
3,000 psi

Socket

Brass

Accuracy

±3 -2-3%



DPG Digital Pressure Gauge

2.5"
(63mm)

Vac to
10,000 PSI

304 SS

±1%



TAS Industrial 5AS Thermometer

**Dial/Scale
Sizes**

5" (125mm)

**Case
Material**

Polypropelene

**Wetted
Parts**

Brass

**Connection
Size**

1/2" NPT



**TBM
Bi-Metal
Thermometer**

**Dial/Scale
Sizes**

1" (25mm)
2" (50mm)
3" (75mm)
4" (100mm)
5" (125mm)
6" (150mm)

**Case
Material**

304 SS

**Wetted
Parts**

304 SS
(welded)

**Connection
Size**

1": N/A
2": 1/4" NPT
3" and larger:
1/2" NPT



**THS Solar Digital
Bi-Metal
Thermometer**

3" (75mm)

304 SS

304 SS

1/2" NPT



**TIM
Industrial 9IT
Thermometer**

9" (230mm)

Aluminum
Valox

Brass

3/4" NPT
1 1/4" swivel
nut



**TNC
Non-Contact
Infrared
Thermometer**

6"

ABS

N/A

N/A



Hydrometers

N/A

Soda Glass

N/A

N/A



Water Finding

Kolor Kut Water Finding Paste, otherwise known as Water Gauging Paste, is used to test for the presence of water in the bottom of oil, diesel, petrol, gasoline, fuel oil, and kerosene tanks. The brown paste is applied to a weighted string or rod, and dipped to the bottom of the tank. The section of the paste that touches water, will immediately turn a brilliant red upon contact, then, once the rod is removed, you can determine the depth of the water by the paste that has changed colour.

Supplied singly or in boxed quantities of 12 tubes. Each tube is 3oz.



Seals



Cable Seals



Indicative Seals



Bolt Seals



ISO/C-TPAT High Security Seals



Tamper-Evident Labels And Tape



Pipe Thread Sealants

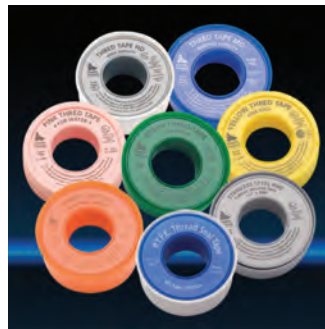

PTFE Tapes



Gasket Makers



Penetrants



Lubricants



Gauging Paste



Marking Paint



Cleaners



Accessories



EverSEAL Sealants



Thred Taper

Fittings

Outlet Bodies, Unions, Plugs & Nipples, Drains & Breathers, Couplings, Connectors, Elbows



Enclosures

Junction Boxes, Terminal Enclosures, Drains and Breathers, Flame Arrestors, Terminal Blocks, Circuit Breaker Handles



Distribution Equipment

Circuit Breakers, Disconnect Switches, Panelboards, Switchrack Assemblies



Plugs & Receptacles

NEMA 4X, Interlocked, Hazardous Locations, Delayed Action, Blade Style, Panel Mount, 30-200 Amp



Controls

Custom Control Panel Operators, Motor Starters, Line Starters, Operator Bodies, IEC Starters, NEMA Starters



Lighting

LED, CFL, HID, Induction, Emergency, for wet/harsh/hazardous areas



Reels

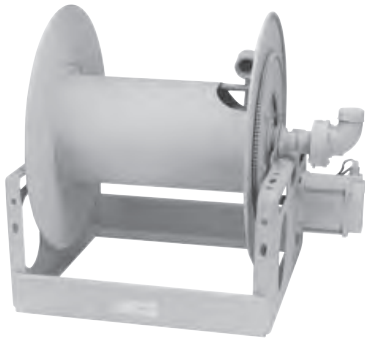

1 1/2"
Manual or Power Rewind
Reels. To handle single 1"
through 1-1/2" I.D. hose



2"
Manual or Power Rewind
Reels. To handle single 1-1/2"
or 2" I.D. hose



3"
Manual or Power Rewind
Reels. To handle 2" through 3"
I.D. hose



4"
Manual or Power Rewind
Reels. To handle 3" or 4" I.D.
hose



5000
Single Wrap Power Rewind
Reels. To handle single
1-1/2" I.D. through 3" I.D.
hose



900
Spring Rewind Reels. To
handle 1-1/4" or 1-1/2" I.D.
hose Bulk Transfer / Fuel
Dispensing / Suction /
Discharge



Series RT

1/4", 3/8", 1/2" I.D.

An economical, lighter hose reel designed for low, medium and high pressure applications.



Series 4000 / 5000 / 5005

1/4", 3/8", 1/2" I.D.

For all general air, water, oil or grease applications.



Series 7000

1/4", 3/8", 1/2", 3/4" I.D.

Our best-selling reel for low, medium and high pressure applications.



Series DP5000 / DP7000

1/4", 3/8", 1/2" I.D.

Compact interlocking base and balanced swivel.



Series D8000 / E8000

1/4", 3/8", 1/2" I.D.

The aluminum cast base and arm offer the highest rigidity among this class of hose reels.



Series 80000 / D80000

3/8", 1/2", 3/4", 1" I.D.

Our largest pedestal-style hose reel with heavy-duty, ball-bearing style swivel for low, medium and high pressure applications.



Series SD10000

3/4", 1" I.D.

Low profile spring driven hose reel designed to handle up to 50' of 3/4" or 1" hose.



Series 9000

1/2", 3/4", 1", 1 1/4", 1 1/2" I.D.

Mobile base reel ideal for high volume air, water, fuel and petroleum applications.



Nordic Series 3100 / 4800

1/2", 3/4", 1", 1 1/4", 1 1/2", 2" I.D.

Great for high volume air, water, fuel and petroleum applications.



Series TH

1/4", 3/8", 1/2" I.D.

Medium pressure for operating hydraulic cylinders, motors or tools.

For over 30 years we have been manufacturing a wide variety of custom fuel dispensers. Our current product line of fabricated dispensers includes marina dispensers in varying flow rate capacities, all enclosed in stainless steel for longer durability, LPG dispensers in both commercial and retail configurations and aviation dispensing cabinets.

As a result of customer demand and our desire to provide a complete portfolio of fuel products, construction of manufacturing facilities for steel tanks was completed in the late eighties. The new factories were strategically located in the Dominican Republic and Puerto Rico to directly serve those markets as well as to allow for inexpensive shipping to other Caribbean nations.

These facilities are able to manufacture tanks in capacities up to 15,000 US Gallons in both above ground and below ground configurations. Both facilities are able to manufacture UL listed tanks and are third party inspected on a regular basis. A wide variety of tank technologies are available to meet or exceed all of the environmental requirements of our sales area. In addition, we are equipped to fabricate a wide variety of fuel dispensers, blending skids, filter skids, pump cabinets, pump and meter assemblies and any other packaged assembly you may want to put together from our vast product line. We will provide a piped, primed and wired modular assembly or skid that can be easily installed in your project with a minimum amount of electrical work, welding or assembly. Please contact us directly for any questions on custom orders



CUSTOM MADE EQUIPMENT



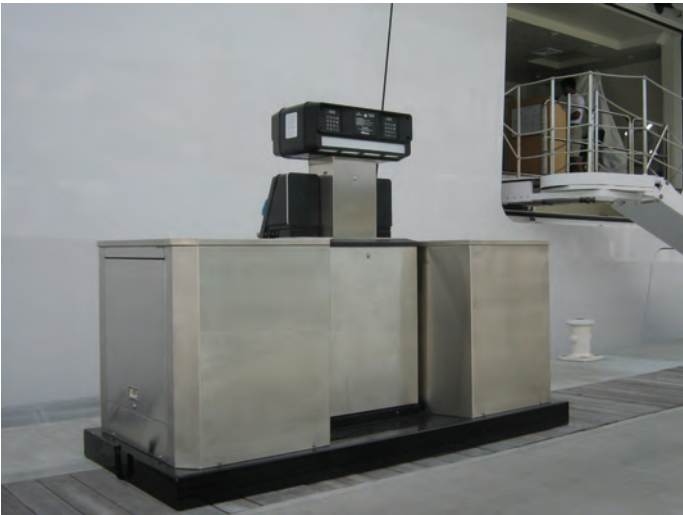



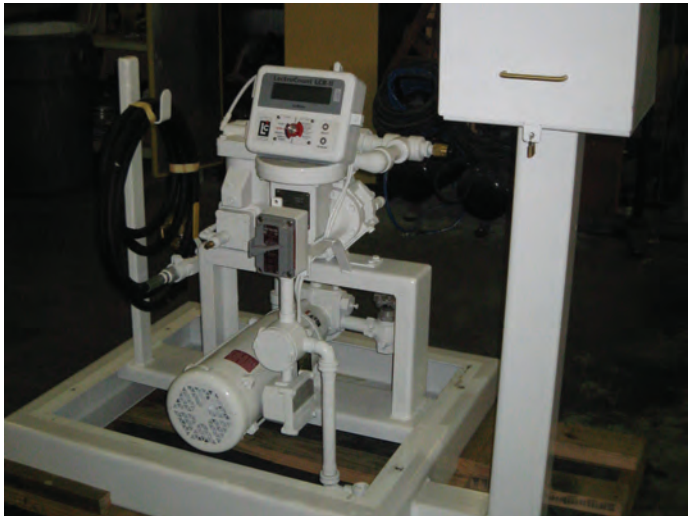
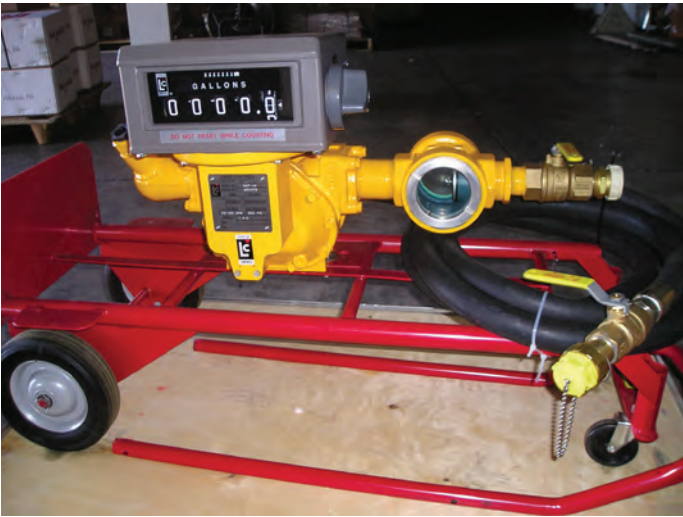



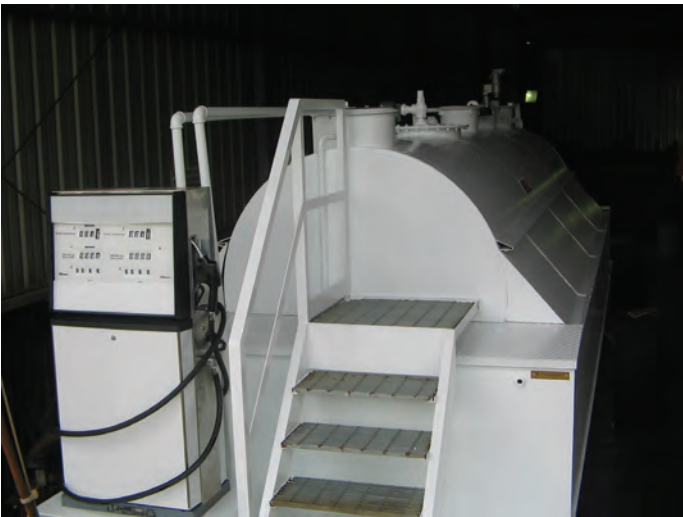

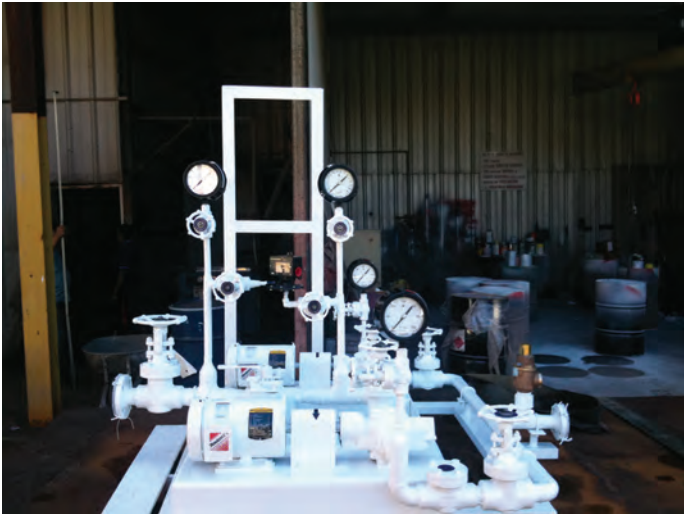





Industrial/Petroleum Pumps

- Red Jacket
- Blackmer
- Roper
- Corken
- Gould
- Price Pump
- Oberdorder
- Fe Petro
- Smlth Precision
- GPI

Compressors Pneumatic Equipment

- Saylor Beal
- Campbell Hausfeld
- Quincy
- Corken
- Blackmer
- Krug
- Plus a large selection of filters, regulators, lubricators and air dryers

Valves

- Lunkenhelmer
- Sharpe
- Smith Cooper
- Jomar Ball Valves
- Strahman Valves, Mixers and Nozzles
- Actuators & Controls
- Conbraco (Apollo)
- Hays
- GMEC

Hoses

- Fuel Handling
- Material Handling
- Food Handling
- Metal Hoses & Flexible Connectors
- Dock Hoses
- LPG hoses
- Marine Hoses
- Floating hoses
- Chemical Transfer
- Special application
- Aviation

Filters

- Central Illinois
- Parker Industrial
- Dixon

LPG & Ammonia Equipment

- Rego Valves, Regulators and Fittings
- Manchester Cylinders
- Above and Below Ground Tanks
- Cylinder Valves
- Blackmer Pumps & Compressors
- Corken Pumps & Compressors
- Smith Precision Pumps
- Liquid Controls Meters
- Liquatech Meters
- Neptune Meters
- Sensus Meters
- Rochester Gauges

Gasoline Service Station Equipment

- Gllbarco Pumps & Dispensers
- Lubrication Equipment
- Veeder Root Leak Detection
- OPW Valves & Fittings
- Fiberlite Sumps
- Storage Tanks
 - Fluids Containment
 - Fiberglass
 - Permatank
 - Composite
 - Steel Aboveground
 - Areo-Power Diked Tanks
- Accufueler Fueling Cabinets
- Manitowoc Lifts
- Tireflators
- LSI Lighting Fixtures
- Island Frames
- Oil & Water Separators
- Ruby Consoles
- Gllbarco POS Systems
- Pressure Washers
- Nozzles
- Vacuum Cleaners
- Fiberglass pipe and Accessories
- Flexible Piping
- Price Signs

Industrial/Petroleum Meters

- Liquid Controls
- Neptune (Red Seal)
- Gasboy
- FillRite
- GPI

Loading Rack and Tank Truck Equipment

- Liquid Loaders
- Swivel Joints
- Coupler/Adapters
 - Emco Wheaton
 - Civacon
- Valves
- Meters
- Valves, Lights, Manholes
 - Betts
 - Allegheny Valve
- Electronics
 - Scully
 - Civacon
- Tift Metal Hoses

Instrumentation

- Gauges & Thermometers
- Leak Detection Systems
- Chatillon Force Measurement And Scales
- Scully Electronics
- L & J Technologies Gauging
- Varec Tank Gauging
- Veeder Root Systems

Piping and Accessories

- Carbon Steel Sch40 & Sch 80
- Galvanized steel Sch 40
- Fiberglass piping
- Grooved End Pipe
- Accessories Victaulic
- Malleable Iron Fittings
- Cast Iron Fittings
- Extra Heavy Carbon Steel Fittings
- Strainers
- Flanges and Bolts
- Gasketing Material, Packing and O'rings Rings

Motors & Speed Reducers

- Baldor
- Weco